

BINS

KLETON STACK & HANG BINS

- Designed to hang from bin racks, panels, rails and carts
- Bins reduce and control inventories, shorten assembly times and minimize parts handling
- Reinforced ribs, on both sides, prevent bins from spreading under loads
- Front, back and side grips for easy handling
- Stackable

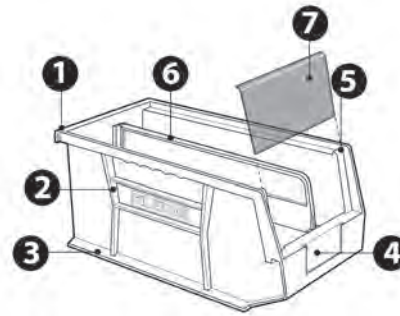
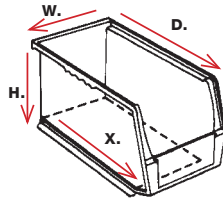
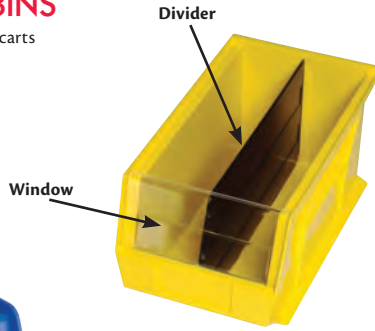

1. Full width hanger supports bins when suspended from louvered panels or rails
2. Reinforced rib design adds strength and prevents spreading when stacked
3. Extra-wide ledges for secure stacking and stability
4. Large front label slots ideal for larger bar code scanning and content identification
5. Anti-slide stop prevents stacked bins from shifting forward
6. Optional dividers increase storage options
7. Optional windows maximize storage capacity, prevent spillage and protect parts from dust and dirt

Blue	Red	Model No.				Series	Outside Dimensions			Inside Dimensions			Inside Bottom Depth X"	Bin Load Capacity lbs.	Uses Divider	Uses Clear Window
		Yellow	Green	Black	Series		W" x D" x H"	W" x D" x H"	W" x D" x H"							
CF820	CF822	CF823	CF821	CF824	30210	4-1/8 x 5-3/8 x 3	3-7/16 x 4-3/4 x 2-13/16	4	10	CB825	-					
CF825	CF827	CF828	CF826	CF829	30220	4-1/8 x 7-3/8 x 3	3-7/16 x 6-3/4 x 2-13/16	6	10	CB826	-					
CF830	CF832	CF833	CF831	CF834	30230	5-1/2 x 10-7/8 x 5	4-3/8 x 10-1/4 x 4-3/4	9	30	CB829	CB814					
CF835	CF837	CF838	CF836	CF839	30235	11 x 10-7/8 x 5	10 x 10-1/4 x 4-3/4	9	50	CB829	CB815					
CF840	CF842	CF843	CF841	CF844	30239	8-1/4 x 10-3/4 x 7	6-9/16 x 10 x 6-3/4	8	50	CB830	CB818					
CF845	CF847	CF848	CF846	CF849	30240	8-1/4 x 14-3/4 x 7	6-9/16 x 14 x 6-3/4	12	60	CB831	CB818					
CF850	CF852	CF853	CF851	CF854	30250	16-1/2 x 14-3/4 x 7	14-3/4 x 14 x 6-3/4	12	75	CB831	CB819					

DIVIDERS

- Maximizes flexibility, keeps contents organized
- Allows for the separation of contents in bins
- Installed in a back to front position



Model No.	Description	Dividers per Case
CB825	For 5-3/8" D x 3" H Bin	6
CB826	For 7-3/8" D x 3" H Bin	6
CB829	For 10-7/8" D x 5" H Bin	6
CB830	For 10-3/4" D x 7" H Bin	6
CB831	For 14-3/4" D x 7" H Bin	6

CLEAR WINDOWS

- Crystal styrene window front increases bin capacity
- Provides quick view on bin contents
- Snaps quickly into place



Model No.	Description	Windows per Case
CB814	5-1/2" W x 5" H	12
CB815	11" W x 5" H	6
CB818	8-1/4" W x 7" H	6
CB819	16-1/2" W x 7" H	6

BIN BUDDY™ & TRI-DEX™ LABEL HOLDERS

- Clear self-adhesive backing adheres to any plastic or metal container
- Clear bar code compatible window protects label from dirt and moisture
- Tri-Dex™ label holders snap into bin slots protecting label or barcode
- Includes a set of laser/ink jet compatible labels, 25/pack
- Extra refill labels are also available, sold 50/pack

Bin not included



OK113

Model No.	Mfg. No.	Dimensions"	Description	Refill Labels
OF212	BB-13	1 x 3	Bin Buddy™, Top/Bottom Load, Self Adhesive	OF216
OF210	BB-35	3 x 5	Bin Buddy™, Side Load, Self Adhesive	OF214
OK113	TR-0813	13/16 x 3	Tri-Dex™, Ideal for Shelf Bins	OK118
OK114	TR-1300	1 x 3	Tri-Dex™, Ideal for Bin Series 30-210, 30-220	OK119
OK116	TR-1754	1 3/4 x 4	Tri-Dex™, Ideal for Bin Series 30-230, 30-250	OK121

CLEAR COVER

- Provides high visibility and accessibility to bin contents
- Easy snap-in installation due to integrated hinge pins
- Clear covers protects from dust, dirt, and debris
- Can be used with dividers



Model No.	Description	Covers per Case
CF855	For 5-3/8" D x 4-1/8" W x 3" H Bin	24
CF856	For 7-3/8" D x 4-1/8" W x 3" H Bin	24
CF857	For 10-7/8" D x 5-1/2" W x 5" H Bin	12
CF858	For 10-7/8" D x 11" W x 5" H Bin	6
CF859	For 10-3/4" D x 8-1/4" W x 7" H Bin	6
CF860	For 14-3/4" D x 8-1/4" W x 7" H Bin	12



HI-STAK PLASTIC BINS

- Innovative stacking design allows for greater visibility and easier access to contents
- Distortion-free from -40°C to 120°C
- Unaffected by oil, alkaline and most acids
- Ideal in production or for store display
- Included with each bin: I.D. card with clear plastic shield, four riser legs and connector clip



Connector clip allows for back-to-back mounting



1" riser legs increase loading capacity and stability



Inclined faceplate with removable label and protector



Built-in extrusions allow side-by-side interlock



Stackable using built-in feet

Model No.				Dimensions					Qty /Case	Wt. lbs.
Blue	Yellow	Green	Red	W"	x	D"	x	H"		
CB260	CB261	CC234	CC242	4 13/16	x	7 1/8	x	3 3/16	60	0.10
CB262	CB263	CC235	CC243	5 7/8	x	9 13/16	x	4 11/16	36	0.15
CB264	CB265	CC236	CC244	8 3/16	x	14	x	6 3/16	18	0.35
CC239	CC240	CC237	CC245	7 7/8	x	17 11/16	x	7	12	0.55
CB266	CB267	CC238	CC246	11 13/16	x	17 11/16	x	7	8	0.60

Add 1 inch to overall height when stacking on legs

WIRE SHELVING UNITS WITH STORAGE BINS



Same great features as the Kleton chromate wire shelving, but with the added convenience of heavy-duty storage bins.

- Adjustable chromate wire shelves
- Wire shelving resists corrosion and provides greater visibility to stored parts
- Wire shelves prevent build up of dust and dirt
- Bins are unaffected by oil, alkaline, and most acids
- Ideal in production or for parts storage
- Stationary units total capacity should not exceed 2000 lbs.
- NSF Certified (wire shelving units only)
- Assembly required



RL815



RL820

Model No.	Shelving Dim. W" x D" x H"	No. of Shelves	Bin Dimensions					No. of Bins	Colour
			W"	x	D"	x	H"		
RL815	36 x 14 x 74	8	8 3/16	x	14	x	6 3/16	28	Blue
RL816	36 x 14 x 74	8	8 3/16	x	14	x	6 3/16	28	Yellow
RL817	36 x 14 x 74	8	8 3/16	x	14	x	6 3/16	28	Green
RL818	36 x 14 x 74	8	8 3/16	x	14	x	6 3/16	28	Red
RL819	36 x 18 x 74	8	7 7/8	x	17 11/16	x	7	28	Blue
RL820	36 x 18 x 74	8	7 7/8	x	17 11/16	x	7	28	Yellow
RL821	36 x 18 x 74	8	7 7/8	x	17 11/16	x	7	28	Green
RL822	36 x 18 x 74	8	7 7/8	x	17 11/16	x	7	28	Red
RL827	48 x 18 x 74	8	7 7/8	x	17 11/16	x	7	28	Blue
			11 13/16	x	17 11/16	x	7	7	Blue
RL828	48 x 18 x 74	8	7 7/8	x	17 11/16	x	7	28	Yellow
			11 13/16	x	17 11/16	x	7	7	Yellow
RL829	48 x 18 x 74	8	7 7/8	x	17 11/16	x	7	28	Green
			11 13/16	x	17 11/16	x	7	7	Green
RL830	48 x 18 x 74	8	7 7/8	x	17 11/16	x	7	28	Red
			11 13/16	x	17 11/16	x	7	7	Red
RL831	48 x 18 x 74	8	7 7/8	x	17 11/16	x	7	7	Blue
			11 13/16	x	17 11/16	x	7	21	Blue
RL832	48 x 18 x 74	8	7 7/8	x	17 11/16	x	7	7	Yellow
			11 13/16	x	17 11/16	x	7	21	Yellow
RL833	48 x 18 x 74	8	7 7/8	x	17 11/16	x	7	7	Green
			11 13/16	x	17 11/16	x	7	21	Green
RL834	48 x 18 x 74	8	7 7/8	x	17 11/16	x	7	7	Red
			11 13/16	x	17 11/16	x	7	21	Red
RL839	36 x 18 x 74	8	7 7/8	x	17 11/16	x	7	7	Blue
			11 13/16	x	17 11/16	x	7	14	Blue
RL840	36 x 18 x 74	8	7 7/8	x	17 11/16	x	7	7	Yellow
			11 13/16	x	17 11/16	x	7	14	Yellow
RL841	36 x 18 x 74	8	7 7/8	x	17 11/16	x	7	7	Green
			11 13/16	x	17 11/16	x	7	14	Green
RL842	36 x 18 x 74	8	7 7/8	x	17 11/16	x	7	7	Red
			11 13/16	x	17 11/16	x	7	14	Red

BINS

QUANTUM™ BINS

- Heavy-duty, virgin, high density polypropylene/polyethylene
- Autoclavable up to 250°F
- Large multiple label slots • Stackable
- Optional dividers and clear windows available for most units
- Hangs on louvered panels, rails and carts
- Jumbo bins cannot hang on louvered panels or rail systems
- Jumbo bins have a stack capacity of up to 100 lbs. and can stack up to six bins high
- Mobile bins come with four swivel 3" casters with brakes
- Made of FDA approved materials

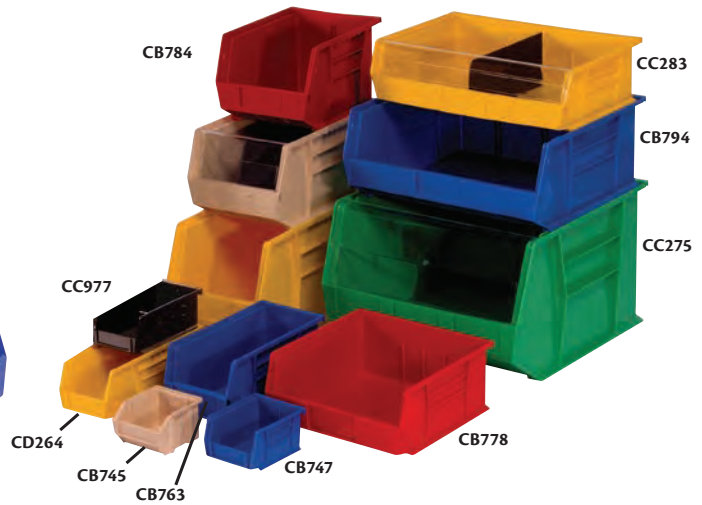

Black	Blue	Yellow	Model No.	Red	Ivory	Green	Mfg. No.	Outside Dimensions			Qty /Case	Bin load Cap. lbs.
								W"	x	D"	x	H"
CC975	CB739	CB741	CB744	CB745	CB745	CC264	QUS 200	4 1/8	x	5	x	3
CC976	CB747	CB750	CB751	CB753	CC265	QUS 210	4 1/8	x	5 3/8	x	3	24
CC977	CB756	CB757	CB759	CB762	CC266	QUS 220	4 1/8	x	7 3/8	x	3	24
CF376	CF377	CF378	CF379	CF380	CF381	QUS 221	6	x	9 1/4	x	5	12
CD276	CD249	CD262	CD263	CD264	CD265	QUS 224	4 1/8	x	10 7/8	x	4	12
CC978	CB763	CB765	CB766	CB768	CC267	QUS 230	5 1/2	x	10 7/8	x	5	12
CC974	CC971	CC972	CC973	CC990	CC970	QUS 234	5 1/2	x	14 3/4	x	5	12
CC980	CB775	CB777	CB778	CB780	CC269	QUS 235	11	x	10 7/8	x	5	6
CC576	CB781	CB783	CB784	CB786	CC270	QUS 239	8 1/4	x	10 3/4	x	7	6
CC577	CB787	CB789	CB790	CB792	CC271	QUS 240	8 1/4	x	14 3/4	x	7	12
CF382	CF383	CF384	CF385	CF386	CF387	QUS 241	8 1/4	x	13 5/8	x	6	12
CF388	CF389	CF390	CF391	CF392	CF393	QUS 242	8 1/4	x	13 5/8	x	8	12
CC983	CC282	CC283	CC284	CC285	CC286	QUS 245	16 1/2	x	10 7/8	x	5	6
CC578	CB794	CB795	CB796	CB797	CC272	QUS 250	16 1/2	x	14 3/4	x	7	6
CC579	CB798	CB800	CB801	CB802	CC273	QUS 255	11	x	16	x	8	4
CC580	CB803	CB804	CB806	CB807	CC274	QUS 260	11	x	18	x	10	4
CC581	CC287	CC288	CC289	CC290	CC291	QUS 265	8 1/4	x	18	x	9	6
CC582	CB808	CB809	CB810	CB811	CC275	QUS 270	16 1/2	x	18	x	11	3
CD674*	CD669*	CD670*	CD671*	CD673*	CD672*	QUS 275MOB	16 1/2	x	18	x	14	3

Divider Model No.	Clear Window Model No.
CB824	-
CB825	-
CB826	-
CF501	CF560
CD250	CD266
CB829	CB814
CC569	CB814
CB829	CB815
CB830	CB818
CB831	CB818
CF394	CF396
CF395	CF397
CC297	CC300
CB831	CB819
CB833	CB820
CB834	CB821
CC298	CC301
CB835	CB822
CB835	CB822

* Mobile unit

OPEN HOPPER STORAGE SHELF UNITS

QUS 239 SERIES

- 28 QUS 239 Series bins 8 1/4" W x 10 3/4" D x 7" H
- Eight heavy-duty grey enamel shelves
- 36" W x 12" D x 76" H
- Cap.: 630 lbs. per shelf
- Shipped knocked down



CF118

QUS 240 SERIES

- 28 QUS 240 Series bins 8 1/4" W x 14 3/4" D x 7" H
- Eight heavy-duty grey enamel shelves
- 36" W x 12" D x 76" H
- Cap.: 630 lbs. per shelf
- Shipped knocked down



CF126

QUS 250 SERIES

- 14 QUS 250 Series bins 16 1/2" W x 14 3/4" D x 7" H
- Eight heavy-duty grey enamel shelves
- 36" W x 12" D x 76" H
- Cap.: 630 lbs. per shelf
- Shipped knocked down



CF132

QUS 240 & 230 SERIES

- 8 QUS 240 Series bins 8 1/4" W x 14 3/4" D x 7" H
- 36 QUS 230 Series bins 5 1/2" W x 10 7/8" D x 5" H
- Nine heavy-duty grey enamel shelves
- 36" W x 12" D x 76" H
- Cap.: 630 lbs. per shelf
- Shipped knocked down



CF135

Black	Blue	Yellow	Model No.	Red	Ivory	Green	Description	No. of Shelves
QUS 239 SERIES BINS SHELF UNIT								
CF176	CF118	CF119	CF120	CF121	CF122	CF122	Starter	8
CF180	CF140	CF141	CF142	CF143	CF144	CF144	Add-On	8
QUS 240 SERIES BINS SHELF UNIT								
CF178	CF123	CF124	CF125	CF126	CF127	CF127	Starter	8
CF182	CF150	CF151	CF152	CF153	CF154	CF154	Add-On	8

Black	Blue	Yellow	Model No.	Red	Ivory	Green	Description	No. of Shelves
QUS 250 SERIES BINS SHELF UNIT								
CF177	CF128	CF129	CF130	CF131	CF131	CF132	Starter	8
CF181	CF145	CF146	CF147	CF148	CF148	CF149	Add-On	8
QUS 240 & 230 SERIES BINS SHELF UNIT								
CF179	CF133	CF134	CF135	CF136	CF136	CF137	Starter	9
CF183	CF175	CF155	CF156	CF157	CF157	CF158	Add-On	9

SHELF BINS

- Economical way to store and display parts and components
- Durable polypropylene
- Designed for use on 12", 18" and 24" deep shelving, or vertical storage and retrieval units
- Shelf bins "nest" when empty
- Bin cups and dividers available
- Manufactured from FDA approved polypropylene

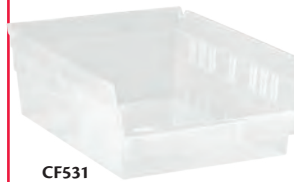
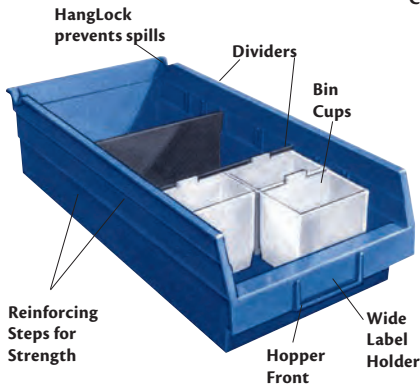
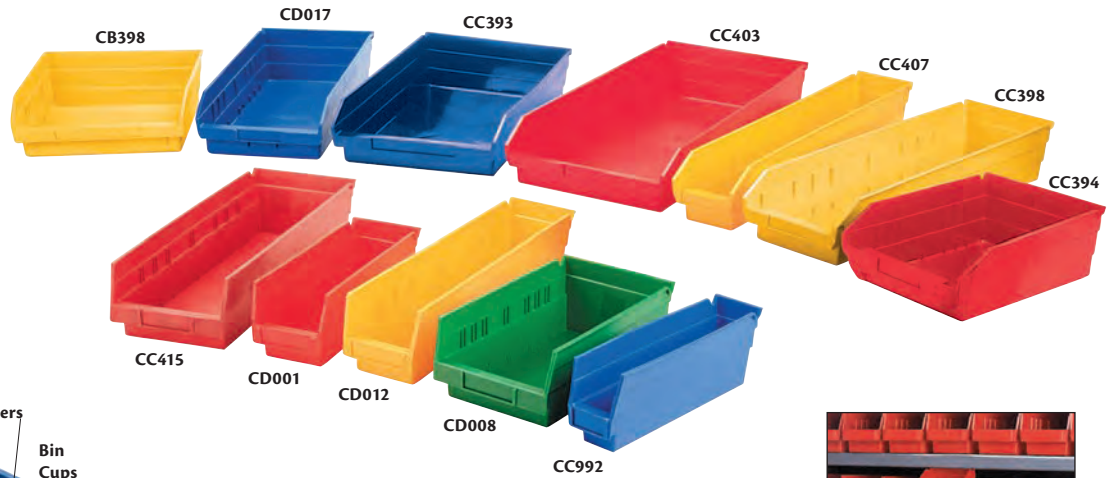

The special built-in hanglock catches the underside of the shelf above, allowing each bin to be tilted out for complete access.

Blue		Red	Model No.	Yellow	Clear	Green	Mfg. No.	Outside Dimensions			Inside Dimensions			Qty /Case	Dividers, up to 7 per bin	Bin Cups Per Bin		
Blue	Red	Yellow	Clear	Green	Mfg. No.	W"	D"	H"	W"	D"	H"	Qty /Case	Dividers, up to 7 per bin	CD035	CD040	CD036	CD041	
CC992	CC994	CC993	N/A	CC995	QSB100	2 3/4	x 11 5/8	x 4	1 5/8	x 10 1/4	x 4	24	N/A	3	N/A	3	N/A	
CC998	CD001	CC999	N/A	CD002	QSB101	4 1/8	x 11 5/8	x 4	3	x 10 1/4	x 4	24	CB861	6	2	6	2	
CD005	CD007	CD006	N/A	CD008	QSB102	6 5/8	x 11 5/8	x 4	5 1/2	x 10 1/4	x 4	12	CB862	9	4	N/A	N/A	
CC393	CC394	CC395	CF531	CD023	QSB107	8 3/8	x 11 5/8	x 4	7 1/2	x 10 3/4	x 3 7/8	20	CB867	12	4	12	4	
CC396	CC397	CC398	CF532	CD026	QSB109	11 1/8	x 11 5/8	x 4	10 3/8	x 10 3/4	x 3 7/8	8	CB869	18	6	18	6	
CD011	CD013	CD012	N/A	CD014	QSB103	4 1/8	x 17 7/8	x 4	3	x 16 1/2	x 4	12	CB861	9	3	9	3	
CD017	CD019	CD018	N/A	CD020	QSB104	6 5/8	x 17 7/8	x 4	5 1/2	x 16 1/2	x 4	12	CB862	15	6	15	6	
CC399	CC400	CC401	CF533	CD029	QSB108	8 3/8	x 17 7/8	x 4	7 1/2	x 16 1/2	x 3 7/8	10	CB867	19	6	19	6	
CC402	CC403	CC404	CF534	CD032	QSB110	11 1/8	x 17 7/8	x 4	10 3/8	x 16 3/8	x 3 7/8	8	CB869	29	8	29	8	
CC405	CC406	CC407	CF535	CD045	QSB105	4 1/8	x 23 5/8	x 4	3 1/4	x 22 1/4	x 3 7/8	8	CB861	13	4	13	4	
CC408	CC409	CC423	CF536	CD048	QSB106	6 5/8	x 23 5/8	x 4	5 1/2	x 22 1/4	x 3 7/8	8	CB862	21	8	21	8	
CC411	CC412	CC413	CF537	CD051	QSB114	8 3/8	x 23 5/8	x 4	7 1/2	x 22 1/4	x 3 7/8	6	CB867	24	8	24	8	
CC414	CC415	CC416	CF538	CD054	QSB116	11 1/8	x 23 5/8	x 4	10 3/8	x 22 1/4	x 3 7/8	6	CB869	35	16	35	16	

BIN DIVIDERS

Model No.	Mfg. No.	Width"	Qty/Case
CB861	DSB101/DSB103	4 1/8	50
CB862	DSB102/DSB103	6 5/8	50
CB867	DSB107	8 1/8	50
CB869	DSB109	11 1/8	50

BIN CUPS

Model No	Mfg. No.	Colour	Dimensions
CD035	QBC111	Blue	3 1/4" x 1 3/4"
CD040	QBC112	Blue	5 1/8" x 2 3/4"
CD036	QBC111	Yellow	3 1/4" x 1 3/4"
CD041	QBC112	Yellow	5 1/8" x 2 3/4"

EXTENDED LABEL HOLDERS, 24 PER BOX

Model No	Mfg. No.	Colour	Angle
CF398	ELH410	Black	10°
CF399	ELH415	Black	45°

RECYCLED SHELF BINS

- Manufactured from recycled 100% post consumer, high density polyethylene
- Available in black only

Model No.	Mfg. No.	Outside Dimensions W" x D" x H"	Qty /Case	Dividers*, up to 7 per bin Model No.
CB303	QSB100BR	2 3/4 x 11 5/8 x 4	48	N/A
CB850	QSB101BR	4 1/8 x 11 5/8 x 4	36	CB861
CB851	QSB102BR	6 5/8 x 11 5/8 x 4	30	CB862
CB852	QSB103BR	4 1/8 x 17 7/8 x 4	24	CB861
CB954	QSB104BR	6 5/8 x 17 7/8 x 4	20	CB862
CB854	QSB105BR	4 1/8 x 23 5/8 x 4	8	CB861
CB855	QSB106BR	6 5/8 x 23 5/8 x 4	8	CB862
CB857	QSB108BR	8 3/8 x 17 7/8 x 4	10	CB867
CB860	QSB114BR	8 1/8 x 23 5/8 x 4	6	CB867
CB304	QSB116BR	11 1/8 x 23 5/8 x 4	6	CB869

* Dividers are made of non-recycled polyethylene

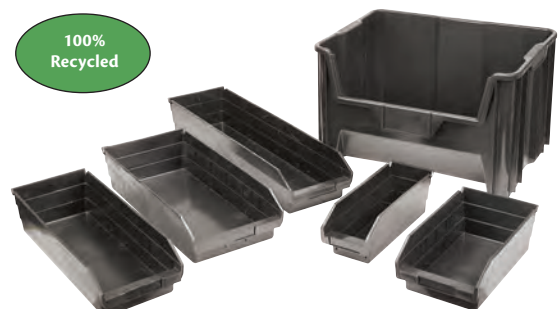

SHELF BINS

EURO DRAWERS

- Heavy-duty design for efficient organization of heavy parts, supplies, tools or equipment
- Injection molded from virgin grade high-impact polystyrene
- 12-gauge thick wall
- Completely waterproof
- Oil and chemical-resistant
- Smooth front curved pull handle has ample room for pressure sensitive identification labels or bar codes
- Front handle has 3/4" opening
- Full width back ledge ensures spill free use

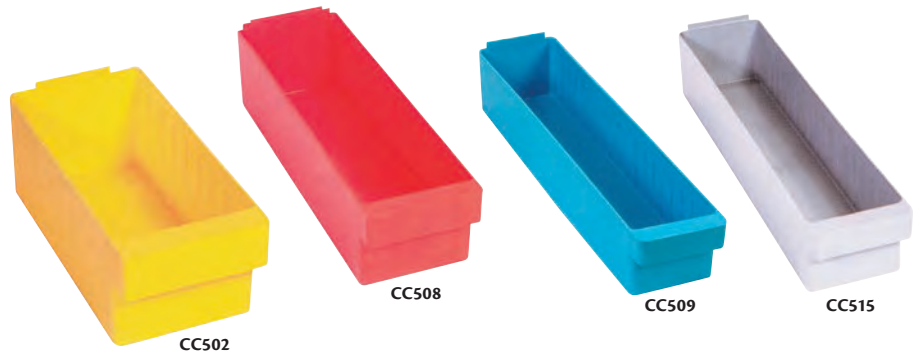

Model No.				Mfg. No.	Outside Dimensions				Qty /Case	Divider Model No.
Blue	Grey	Red	Yellow		W"	x D"	x H"			
CE289	CE291	CE292	CE290	QED401	5 9/16	x 11 5/8	x 2 5/8	24	CE309	
CE293	CE295	CE296	CE294	QED501	3 3/4	x 11 5/8	x 4 5/8	24	CC518	
CC501	CC503	CC504	CC502	QED601	5 9/16	x 11 5/8	x 4 5/8	24	CC517	
CC505	CC507	CC508	CC506	QED602	5 9/16	x 17 5/8	x 4 5/8	24	CC517	
CC509	CC511	CC512	CC510	QED603	5 9/16	x 23 7/8	x 4 5/8	12	CC517	
CC513	CC515	CC516	CC514	QED604	3 3/4	x 17 5/8	x 4 5/8	24	CC518	
CE305	CE307	CE308	CE306	QED606	8 3/8	x 17 5/8	x 4 5/8	24	CE312	
CE297	CE299	CE300	CE298	QED701	8 3/8	x 11 5/8	x 4 5/8	24	CE312	
CE301	CE303	CE304	CE302	QED801	11 1/8	x 11 5/8	x 4 5/8	12	CE314	

Add dividers to Euro Drawers for additional storage possibilities!



STORE MORE™ PLASTIC SHELF BINS

- Durable, high density polypropylene bins
- Economical way to store and display parts and components
- Feature a moulded-in label holder and a built-in rear hang-lock which allows bins to tilt out for complete access when on shelving
- A wide hopper front allows complete access to the contents of the bin
- Edges are reinforced for added strength
- Designed for 12", 18" and 24" deep shelf units, racks or standard shelving
- Bins are waterproof, impervious to most chemicals and unaffected by grease or oil



Store more with 6" high shelf bins

Blue	Model No.		Mfg. No.	Outside Dim.			Inside Dim.			Dividers up to 7/bin	Bin Cups/Bin	
	Yellow	Red		W"	x D"	x H"	W"	x D"	x H"		CD036	CD041
CF212	CF213	CF214	QSB201	4 1/8	x 11 5/8	x 6	3	x 10 1/6	x 6	CF248	6	2
CF215	CF216	CF217	QSB202	6 5/8	x 11 5/8	x 6	5 1/2	x 10 1/6	x 6	CF249	9	4
CF218	CF219	CF220	QSB207	8 3/8	x 11 5/8	x 6	7 1/8	x 10 1/6	x 6	CF250	12	4
CF221	CF222	CF223	QSB209	11 1/8	x 11 5/8	x 6	10	x 10 1/6	x 6	CF251	18	6
CF224	CF225	CF226	QSB203	4 1/8	x 17 7/8	x 6	3	x 16 1/2	x 6	CF252	9	3
CF227	CF228	CF229	QSB204	6 5/8	x 17 7/8	x 6	5 1/2	x 16 1/2	x 6	CF253	15	6
CF230	CF231	CF232	QSB208	8 3/8	x 17 7/8	x 6	7 1/8	x 16 1/2	x 6	CF254	19	6
CF233	CF234	CF235	QSB210	11 1/8	x 17 7/8	x 6	10	x 16 1/2	x 6	CF255	29	8
CF236	CF237	CF238	QSB205	4 1/8	x 23 5/8	x 6	3	x 22 1/8	x 6	CF256	13	4
CF239	CF240	CF241	QSB206	6 5/8	x 23 5/8	x 6	5 1/2	x 22 1/8	x 6	CF257	21	8
CF242	CF243	CF244	QSB214	8 3/8	x 23 5/8	x 6	7 1/8	x 22 1/8	x 6	CF258	24	8
CF245	CF246	CF247	QSB216	11 1/8	x 23 5/8	x 6	10	x 22 1/8	x 6	CF259	35	16

BIN CUPS

Model No	Dimensions			
	W"	x D"	x H"	
CD036	3	x 1 3/4	x 3	
CD041	5 1/8	x 2 3/4	x 3	



STORE-MAX SHELF BINS

- Helps maximize and organize your space
- Features a molded-in label holder and built-in rear hanglock which allows bin to tilt out for easy access
- Wide hopper front allows for complete access
- Reinforced edges for additional strength
- Designed for use on 12", 18" and 24" deep shelving
- Bins nest when empty



Model No.				Mfg. No.	Outside Dim.				Dividers up to 7/bin	Bin Cups/Bin				
Blue	Red	Yellow	Clear		W"	x	D"	x		H"	CD036	CD041	CD035	CD040
CF864	CF865	CF866	CF867	QSB801	4 3/8	x	11 5/8	x	8	CF912	6	2	6	2
CF868	CF869	CF870	CF871	QSB802	6 5/8	x	11 5/8	x	8	CF913	9	4	9	4
CF872	CF873	CF874	CF875	QSB807	8 3/8	x	11 5/8	x	8	CF914	12	4	12	4
CF876	CF877	CF878	CF879	QSB809	11 1/8	x	11 5/8	x	8	CF915	18	6	18	6
CF880	CF881	CF882	CF883	QSB803	4 3/8	x	17 7/8	x	8	CF916	9	3	9	3
CF884	CF885	CF886	CF887	QSB804	6 5/8	x	17 7/8	x	8	CF917	15	6	15	6
CF888	CF889	CF890	CF891	QSB808	8 3/8	x	17 7/8	x	8	CF918	19	6	19	6
CF892	CF893	CF894	CF895	QSB810	11 1/8	x	17 7/8	x	8	CF919	29	8	29	8
CF896	CF897	CF898	CF899	QSB805	4 3/8	x	23 5/8	x	8	CF920	13	4	13	4
CF900	CF901	CF902	CF903	QSB806	6 5/8	x	23 5/8	x	8	CF921	21	8	21	8
CF904	CF905	CF906	CF907	QSB814	8 3/8	x	23 5/8	x	8	CF922	24	8	24	8
CF908	CF909	CF910	CF911	QSB816	11 1/8	x	23 5/8	x	8	CF923	35	16	35	16

STORE-MAX DIVIDERS

- Colour: Black
- Fits horizontally across bins to create compartments



Model No.	Mfg No.	Description
CF912	DSB801	Divider, 3" wide
CF913	DSB802	Divider, 5 1/2" wide
CF914	DSB807	Divider, 7 1/8" wide
CF915	DSB809	Divider, 10" wide
CF916	DSB803	Divider, 3" wide
CF917	DSB804	Divider, 5 1/2" wide
CF918	DSB808	Divider, 7 1/8" wide
CF919	DSB810	Divider, 10" wide
CF920	DSB805	Divider, 3" wide
CF921	DSB806	Divider, 5 1/2" wide
CF922	DSB814	Divider, 7 1/8" wide
CF923	DSB816	Divider, 10" wide

DIVIDER LABEL TAB

- Improve visibility of bin labels and scanning of barcodes
- Colour: Black



Model No.	Mfg No.	Description	Qty/Box
CF925	DLT-6	Black Divider Label Tab	6

BIN CUPS



Model No.	Mfg No.	Colour	Description
CD035	QBC111	Blue	Bin Cup, 3 1/4" x 1 3/4" x 3"
CD036	QBC111	Yellow	Bin Cup, 3 1/4" x 1 3/4" x 3"
CD040	QBC112	Blue	Bin Cup, 5 1/8" x 2 3/4" x 3"
CD041	QBC112	Yellow	Bin Cup, 5 1/8" x 2 3/4" x 3"

SHELF BINS - EXTENDED LABEL HOLDERS

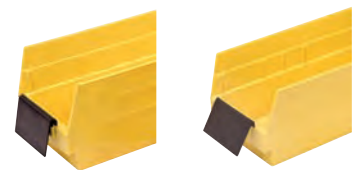

Model No.	Mfg No.	Colour	Angle	Qty/Box
CF398	ELH410	Black	10°	24
CF399	ELH415	Black	45°	24

CLEAR LABEL HOLDER & INSERT

- Laser & inkjet compatible inserts
- 8 1/2" x 11" perforated sheets included
- Colour: Clear
- Fits all 8" high Quantum™ shelf bins



Model No.	Mfg No.	Description	Qty/Box
CF924	LTR-1253	Label Holder & Insert	25

CONTAINERS

GIANT STACKING CONTAINER™

- Injection-molded from high density polyethylene
- Extra heavy, double wall thickness with interlock preformed lip allows containers to stack securely
- Molded carrying handle on backside
- Molded-in divider and label slots
- Optional windows available
- Can withstand temperatures ranging from -40° to 250°F
- Waterproof, will not rust or corrode
- Unaffected by chemicals and solvents
- Mobile bin comes with two swivel, two rigid 3" casters
- 250-lb. mobile capacity
- 150-lb. stack capacity

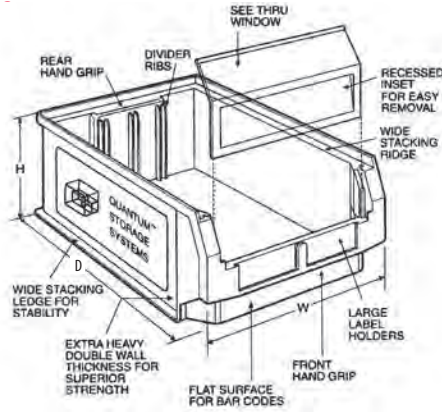

Model No.				Mfg. No.	Outside Dimensions			Qty /Case
Blue	Green	Red	Yellow		W"	x D"	x H"	
CC361	CC362	CC363	CC364	QMS531	12 3/8	x 19 3/4	x 5 7/8	6
CC365	CC366	CC367	CC368	QMS532	12 3/8	x 19 3/4	x 7 7/8	6
CC369	CC370	CC371	CC372	QMS533	12 3/8	x 19 3/4	x 11 7/8	3
CC373	CC374	CC375	CC376	QMS543	18 3/8	x 19 3/4	x 11 7/8	3
CC377*	CC378*	CC379*	CC380*	QMS743	18 3/8	x 29	x 11 7/8	1
CC447*	CC449*	CC448*	CC450*	QMS843MOB**	18 3/8	x 29	x 11 7/8	1

Divider Model No.	Qty /Case	Window Model No.	Qty /Case
CC381	6	CC385	12
CC382	6	CC386	6
CC383	3	CC387	6
CC384	3	CC388	6
-	-	-	-
-	-	-	-

* Includes heavy-duty spread bar for extra strength and support. ** Mobile bins

GIANT STACKING CONTAINERS

- Designed for multiple applications in recycling, storing parts, tools and warehouse items
- Will stack up to six high creating sturdy, tall storage systems
- Large grip side handles
- Extra thick side walls with reinforcing ribs allow for 100-lb. stack capacity per bin
- Six 1/4" drill holes in bottom allow for drainage
- Outside dimensions: 19 7/8" W x 15 1/4" D x 12 7/16" H
- Optional clear window and labels are available



Model No.					Mfg. No.	Qty /Case
Grey	Blue	Ivory	Black	Red		
CB838	CB839	CB841	CB842	CC305	QGH700	3



QUANTUM™ HULK CONTAINERS

- Heavy-duty injection-molded polypropylene stackable containers
- Organize and store your larger bulky items
- Extra large stacking containers offer a generous 2 to 2 1/2' in length to store your larger items
- Ideal for back-to-back use on 48" pallet rack or heavy-duty, extra deep shelving, and are available in a variety of widths and heights
- Heavy-duty front, back and side grips allow for easy handling
- Optional clear plastic window increases bin capacity and provides a quick view of the bin contents
- Optional dividers maximize flexibility and keep contents organized
- Wide stacking ledge and anti-slide lock keep stacked bins steady and prevent forward shifting
- Waterproof bins resist rust and corrosion
- Bins are autoclavable up to 250°F and are resistant to extreme cold
- Do not hang on louvered panels or rail systems

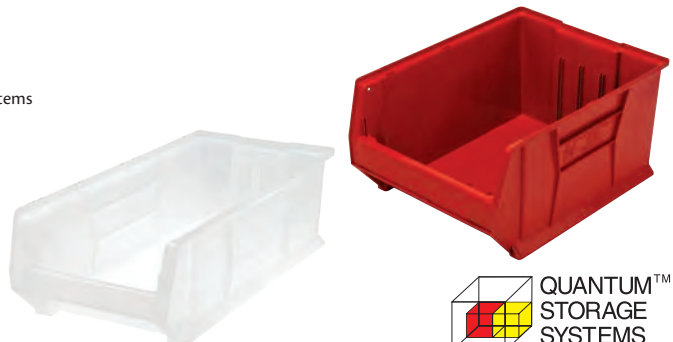

Model No.				Mfg. No.	Outside Dimensions		
Blue	Red	Yellow	Clear		W"	x D"	x H"
CD545	CD546	CD547	CF525	QUS950	8 1/4	x 23 7/8	x 7
CD548	CD549	CD550	CF526	QUS951	8 1/4	x 23 7/8	x 9
CD551	CD552	CD553	CF527	QUS952	11	x 23 7/8	x 7
CD554	CD555	CD556	CF528	QUS953	11	x 23 7/8	x 10
CD557	CD558	CD559	CF529	QUS954	16 1/2	x 23 7/8	x 11
CD560	CD561	CD562	CF530	QUS955	18 1/4	x 23 7/8	x 12
CF196	CF197	CF198	-	QUS970	8 1/4	x 29 7/8	x 7
CF199	CF200	CF201	-	QUS973	11	x 29 7/8	x 10
CF202	CF203	CF204	-	QUS974	16 1/2	x 29 7/8	x 11
CF205	CF206	CF207	-	QUS975	18 1/4	x 29 7/8	x 12
CF208	CF209	CF210	-	QUS976	16 1/2	x 29 7/8	x 15

Divider Model No.	Window Model No.
CD563	CD569
CD564	CD570
CD563	CD571
CD566	CD572
CD567	CD573
CD568	CD574
-	CD569
-	CD572
-	CD573
-	CD574
-	CF211

STACK & NEST TOTES

- Will stack with or without lids for maximum storage and shipping
- Ability to stack and can be turned 180° to nest when empty
- Textured bottoms ensure safe and easy, non-slip grip transit on conveyors
- Injection-molded from high-density polyethylene material
- Will not rust, corrode or bend out of shape
- Are unaffected by chemicals and are waterproof

- Fit on standard 48" x 40" pallets
- Can withstand temperature ranges from -10°F to 250°F
- Ribs under lip prevent jamming when nested
- Handle grips on either side
- Made of FDA compliant materials



Optional lids protect container contents. As pictured, lids can be fastened and locked for added security



All nine sizes of totes have the ability to use the optional clear label holder. It securely attaches to SNT with or without lid for easy part identification.

CONTAINERS

CONTAINERS				COVERS														
Blue	Model No. Grey	Red	MFG No.	Outside Dimensions			Inside Dimensions			Qty /Case	Blue	Model No. Grey	Red	Qty /Case				
				L"	x	W"	x	H"	L"	x	W"	x	H"					
CC315	CC316	CC317	SNT180	18	x	11	x	6	15 1/4	x	9 3/8	x	5 7/8	6	CC342	CC343	CC344	6
CC318	CC319	CC320	SNT185	18	x	11	x	9	15 1/8	x	9 1/8	x	8 7/8	6	CC342	CC343	CC344	6
CC321	CC322	CC323	SNT190	19 1/2	x	15 1/2	x	10	16	x	13 1/4	x	9 7/8	6	CC345	CC346	CC347	6
CC324	CC325	CC326	SNT195	19 1/2	x	15 1/2	x	13	15 7/8	x	13 3/8	x	12 7/8	6	CC345	CC346	CC347	6
CC327	CC328	CC329	SNT200	19 1/2	x	13 1/2	x	8	16 3/8	x	11 1/2	x	7 7/8	6	CC348	CC349	CC350	6
CC330	CC331	CC332	SNT225	23 1/2	x	19 1/2	x	10	19 3/8	x	16 7/8	x	9 7/8	3	CC351	CC352	CC353	3
CC333	CC334	CC335	SNT230	23 1/2	x	19 1/2	x	13	19 1/2	x	16 7/8	x	12 7/8	3	CC351	CC352	CC353	3
CC336	CC337	CC338	SNT240	23 1/2	x	15 1/2	x	12	19 5/8	x	13	x	11 7/8	3	CC354	CC355	CC356	3
CC339	CC340	CC341	SNT300	29 1/2	x	19 1/2	x	15	25 1/8	x	16 5/8	x	14 7/8	3	CC357	CC358	CC359	3

Model No. CC360

Label holder, accommodates up to 3" x 5". Fits all SNT containers.

JUMBO PLASTIC CONTAINERS

- Extra-large size provides massive amount of storage capacity
- Guaranteed unbreakable and distortion-free from -40°C to 120°C
- Unaffected by oil, alkaline, and most acids
- Nesting design allows for minimal storage space when not in use
- Stackable for added space savings, up to four high
- Outside Dimensions: 15 1/2" W x 25" D x 13" H
- Capacity: 200 lbs.



Model No.	Colour	Model No.	Colour
CF328	Blue	CF329	Green
CF330	Yellow	CF327	Red

QUANTUB NESTING TOTES

- High-density polyethylene
- Rolled top rim for comfortable grip
- Eight 1/4" position drill holes on bottom allow for drainage
- Dimensions: 24 1/2" L x 19" W x 9 1/2" H
- Made of FDA approved materials



Model No. CD244 Grey
Model No. CD434 Blue



COLLAPSIBLE CONTAINERS

- Polypropylene construction
- Collapses to 21" L x 14" W x 2" H for convenient storage
- Open dimensions: 21" L x 14" W x 10 1/2" H
- Reinforced base for added durability
- 16 heavy-duty steel pins built in for increased strength
- Capacity: 160 lbs.

Model No. CF326



STACK-N-NEST CONTAINERS

STACK-N-NEST PLASTIC CONTAINERS

- Polyewton® Stack-N-Nest containers used in general manufacturing, food processing and distribution applications
- Injection-molded from high-impact polyolefins
- Will not rust, rot or corrode, resist damaging effects of oil, most chemical solvents, water and steam
- Stack without lids
- Nest at alternating 180° positions when empty
- Withstands wide temperature variances
- Easily cleaned

Blue & grey bins made of FDA compliant materials



CONTAINERS

Grey	Model No.			Mfg. No.	Outside Dim. Top			Outside Dim. Bottom			Volume cu.ft.	Nesting Ratio	Wt. lbs.	LIDS				
	Red	Blue	Blue		L"	x	W"	x	H"	L"				x	W"	Grey	Red	Blue
CA341	CC859	CC868	CC868	SN2012-6	20.1	x	13.0	x	6.2	18.5	x	11.5	0.6	2.1:1	2.1	CA334	CC877	CC883
CA344	CC860	CC869	CC869	SN2414-8	24.0	x	14.1	x	7.9	21.8	x	11.5	1.1	4:1	3.4	CA337	CC880	CC886
CA342	CC861	CC870	CC870	SN2013-12	19.4	x	12.9	x	12.1	17.3	x	10.9	1.3	4:1	3.8	CA335	CC878	CC884
CA343	CC862	CC871	CC871	SN2117-12	21.0	x	17.0	x	12.0	18.8	x	15.0	1.8	4:1	5.0	CA336	CC879	CC885
CA346	CC863	CC872	CC872	SN2618-10	26.1	x	18.7	x	10.5	24.0	x	15.9	2.1	4:1	5.4	CA339	CC882	CC888
CA348	CC864	CC873	CC873	SN3022-6	29.6	x	22.4	x	6.1	28.3	x	21.0	2.1	4:1	4.8	N/A	N/A	N/A
CA347	CC865	CC874	CC874	SN2818-10	28.4	x	18.7	x	10.5	26.0	x	15.9	2.3	4:1	5.8	N/A	N/A	N/A
CA345	CC866	CC875	CC875	SN2420-13	24.0	x	20.0	x	13.0	21.6	x	17.7	2.7	4:1	6.1	CA338	CC881	CC887
CA349	CC867	CC876	CC876	SN3024-15	30.1	x	24.0	x	15.1	27.0	x	21.0	4.7	4.5:1	11.0	N/A	N/A	N/A

STACK-N-NEST PLEXTON CONTAINERS

- Ideal solution for heavy-duty storage, work-in-process and distribution applications
- Can withstand temperatures as low as -60°F and as high as 250°F (continuous)
- Resistant to moisture, chemicals, solvents and most oils
- Capacity: 500 lbs. per container



CONTAINERS

Red	Model No.		Mfg. No.	Outside Dim. Top			Inside Dim. Top			Qty /Case	GREY LIDS		DOLLIES	
	Grey	Grey		L"	x	W"	x	H"	L"		x	W"	Model No.	Model No.
CD179	CD193	CD193	SN1610-5	17.9	x	10.8	x	5	15.9	x	10.1	10	CD216	CD225
CD180	CD194	CD194	SN1812-6	19.8	x	12.8	x	6	18.1	x	11.9	10	CD217	CD226
CD181	CD195	CD195	SN1812-8	20.6	x	13.0	x	8	18.0	x	12.3	10	CF672	CD227
CD182	CD196	CD196	SN2010-7	24.1	x	11.4	x	6.9	20.0	x	10.7	10	CD219	CD228
CD183	CD197	CD197	SN2010-9	24.1	x	11.4	x	9	20.0	x	10.6	10	CD219	CD228
CD184	CD198	CD198	SN2214-5	24.3	x	14.8	x	5.1	21.7	x	14.0	8	CD220	CD229
CD185	CD199	CD199	SN2214-8	24.3	x	14.8	x	8	21.5	x	13.9	8	CD220	CD229
CD186	CD200	CD200	SN2217-6	25.3	x	18.1	x	6.1	21.4	x	18.1	10	CD221	CD230
CD187	CD201	CD201	SN2217-10	25.3	x	18.1	x	10.1	22.8	x	17.3	5	CD221	CD230
CD188	CD202	CD202	SN2419-4	27.5	x	19.9	x	14.1	23.1	x	18.9	5	CD222	CD231
CD189	CD203	CD203	SN2713-7	29.6	x	13.8	x	7	26.7	x	12.9	10	N/A	N/A
CD190	CD204	CD204	SN2716-11	30.6	x	16.9	x	11.1	26.3	x	15.9	5	CD223	CD232
CD191	CD205	CD205	SN3023-8	34.1	x	24.0	x	8.1	30.1	x	21.6	5	N/A	N/A
CD192	CD206	CD206	SN3919-14	42.5	x	20.1	x	14.1	38.1	x	19.0	5	CD224	CD233

FDA APPROVED POLY CONTAINERS

BUS/UTILITY BOXES

- Made of durable, commercial grade plastic
- Reinforced handles, bottom and ribs for added strength
- Dimensions: 20" L x 15" W x 5" H
- Capacity: 17.5 L
- Certified to NSF Std. #2 (splash zone)
- USDA Meat & Poultry Equipment Group Listed and assists in complying w/HACCP guidelines



Model No. CD445 Grey
Mfg. No. 3349
Model No. CD446 White
Mfg. No. 3349
Model No. CD662 Grey Cover
Mfg. No. 3648



GENERAL PURPOSE PAILS

- Snap on lids available:
Dry seal type or **gasket type** for liquid handling
- Galvanised steel handles except **CB040**



ROPAK

Model No.	Description	Dimensions Dia" x W"	Lid Type	Wt. lbs.
CB040	4-L Pail w/Plastic Handle	8 1/4 x 6	-	0.5
CB039	Lid for Pails 4, 5, 6 L w/Static Joint	8 1/2 x 1/2	Gasket	0.2
CB043	11.4-L Pail w/Metal Handle	11 x 9	-	1.1
CB041	Lid for Pails 11.4 L w/o Static Joint	11 3/8 x 5/8	Dry Seal	0.3
CB046	20-L Pail w/Metal Handle	11 7/8 x 15 3/8	-	2.0
CC426	Lid for 20-L pail	12 1/2 x 5/8	Dry Seal	0.4
CB045	Heavy-duty Lid for 20 and 23-L Pails w/Pouring Spout	12 1/8 x 3/4	Gasket	0.6

CYLINDRICAL TANKS

- Easy to clean and heavy-duty cylindrical tanks
- Ideal for mixing and storage of chemicals and food products
- Molded from 100% virgin LLDPE (linear low density polyethylene)
- Can remain full of liquids at room temperature without support
- An economical alternative to stainless steel tanks
- Naturally translucent so that the product level can be viewed at a glance
- Includes a lid
- Accepted for use in Canadian food processing facilities



Model No.	Mfg. No.	Capacity Gallons	Inside Diameter"	Depth"	Wall Thickness"	Tank Weight lbs.	Lid Weight lbs.
CF793	1635	25	16	35	3/16	8	1
CF794	2234	45	22.5	34	3/16	17	3
CF795*	3048	125	30	48	1/4	38	-

* Lid not included

CROSS STACK BINS

- Ideal for production, assembly and order picking
- Injection-molded from high-impact polyethylene; will not crack or rust, and easy to clean
- Can be turned 90° to cross stack
- Built-in handle and bottom grooves for easy handling
- Capacity: 100 lbs.
- Made of FDA compliant materials
- Optional clear label holder **CC360**
- Drill hole pattern on bottom can be opened for drainage purposes



CONTAINERS

Model No.			Dimensions			LIDS		
Blue	Grey	White	L"	W"	H	Blue	Grey	White
CD583	CD584	CD585	17 1/4	x 11	x 12	CF016	CD586	CF017
CD247	CD246	CD248	25 1/8	x 16	x 8 1/2	CF018	CD606	CF019

MOBILE INGREDIENT BINS

- Provide storage, protection and easy movement of all your ingredients with a hinged lid
- Smooth inside surface for easy cleaning
- 3" heavy-duty casters (two fixed, two swivel) provide both stability and manoeuvrability
- Made of FDA compliant materials
- Accepted for use in Canadian food processing facilities



Model No.	Capacity		Outside Dimensions			Lid	Wt. lbs.
	Cu. ft.	Imperial Gal.	L" x W" x H"				
NG953	3.36	21	29 x 12.25 x 27	Hinged	20		
NG954	4.4	28	29 x 15 x 27	Hinged	25		
NG955	6	45	33 x 19 x 29	Sliding	35		

PROSAVE™ MOBILE INGREDIENT BINS WITH 32-OZ. SCOOP

- Seamless construction, rounded corners and smooth walls make these bins easy to clean and bacteria free
- Clear, see-through lid with slide-back feature ideal for placing bin under counters
- Includes a scoop hook allowing scoop to be stored in bin and out of product, an ideal solution where cross contamination is a concern, and a 32-oz scoop
- USDA meat and poultry listed
- NSF Certified
- Made of FDA compliant materials



Model No.	Description	Capacity Cu. ft.	Dimensions		
			L" x W" x H"		
CA616	Slant front	2 3/4	29.25 x 13.13 x 28		
CA617	Slant front	3 1/2	29.50 x 15.50 x 28		
CA618	Slant front	4 1/8	29.75 x 18 x 28		
CC425	Flat front	3 3/4	22 x 23 x 23		

STAKPAK & DIVIDER BOX CONTAINERS

STAKPAK PLUS 4845 SYSTEM CONTAINERS

- Stack-only, injection molded, straight-wall modular containers
- High-density polyethylene (HDPE)
- Reinforced external ribbing adds maximum stacking strength

- Smooth, straight interior walls provide maximum space utilisation and easy cleaning
- Modular design optimizes cube on standard 45" x 48" pallet, allows for mixing and matching of various sizes

- Ergonomically designed handles for comfort and safety
- Containers hold up under temperatures from -10°F to 120°F
- Optional cardholders available

ORBIS

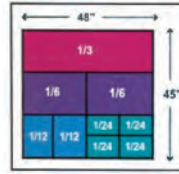

48" x 15" (1/3)
24" x 15" (1/6)
12" x 15" (1/12)
12" x 7" (1/24)

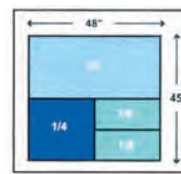

48" x 22" (1/2)
24" x 15" (1/4)
24" x 11" (1/8)

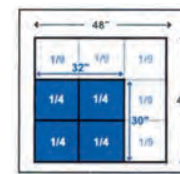

16" x 15" (1/4)
on AIAG 30" x 32"
15" x 15" (1/9)
on AIAG 45" x 48"

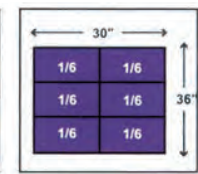

12" x 15" (1/6)

Model No.			Pallet Modularity (AIAG)		Outside Dimensions		Total Container Height"	Product Clearance"	Volume cu.ft.	48' Trailer Capacity (containers)	Wt. lbs.	Lids Model No.			Cardholder Model No.
Medium Green	Grey	Royal Blue	30" x 36"	45" x 48"	Top L" x W"	Bottom L" x W"		*				Medium Green	Grey	Royal Blue	
STAKPAK CONTAINERS															
CA498	CA499	CC112	1/12	1/24	12.0 x 7.4	12.0 x 7.4	5.0	4.5	0.1	8640	1.1	N/A	CA488	N/A	CA448
CA500	CA501	CC113	1/6	1/12	12.0 x 15.0	12.0 x 15.0	5.0	4.4	0.3	4320	1.6	CA489	CA490	CC121	CA448
CA502	CA503	CC114	1/6	1/12	12.0 x 15.0	12.0 x 15.0	7.5	6.8	0.5	3456	2.2	CA489	CA490	CC121	CA449
CA504	CC174	CC115	1/6	1/12	12.0 x 15.0	12.0 x 15.0	9.5	8.8	0.6	2304	2.5	CA489	CA490	CC121	CA449
CA507	CA508	CC116	-	1/6	24.0 x 15.0	24.0 x 15.0	5.0	4.5	0.7	2592	3.0	CA491	CA492	CC122	CA448
CA509	CA510	CC117	-	1/6	24.0 x 15.0	24.0 x 15.0	7.5	6.8	1.1	1728	3.6	CA491	CA492	CC122	CA449
CA511	CA512	CC118	-	1/6	24.0 x 15.0	24.0 x 15.0	9.5	8.8	1.4	1296	4.4	CA491	CA492	CC122	CA449
CA505	CA506	CC119	-	1/6	24.0 x 15.0	24.0 x 15.0	14.5	13.8	2.2	864	5.7	CA491	CA492	CC122	CA449

STAKPAK LIDS

-	CA488	-	-	-	12.0 x 7.4						0.4
CA489	CA490	CC121	-	-	12.0 x 15.0						0.6
CA491	CA492	CC122	-	-	24.0 x 15.0						2.1

* When containers are stacked on top of each other approximately 1/2" is lost to nesting.

CARDHOLDERS

Model No.	Dimensions L" x W"
CA448	8.5 x 4.0
CA449	8.5 x 4.6

DIVIDER BOX® CONTAINERS

- Divider Box® (DC) series containers are injection-molded HDPE
- DG series are injection-molded from high-density FDA approved polyethylene which resists most solvents and chemicals
- Large, flat areas on all four sides for content identification
- Comfort grip handle
- Stacking rims and multi-ribbed external sides provide high impact strength
- All containers can be divided into compartments by length and/or width
- Molded-in stacking ridge assures containers will stack securely with or without covers
- One set of cardholder snaps and security tie holes on two ends included on DC models only
- Full range of optional accessories available including hook and loop card holders for DG models and snap-on card holders for DC models, vertical dividers and covers
- Optional dolly (CF400) allows for easy transport



CARD HOLDERS

Model No.			Mfg. No.	Dimensions			Volume cu.ft.	Wt. lbs.	Short Dividers		Long Dividers		Clear Lids Model No.	Snap-On or Hook & Loop Model No.
Grey	Red	Light Blue		L" x W" x H"	L" x W" x H"	L" x W" x H"			Model No.	No. of Slots	Model No.	No. of Slots		
CA562	CC833	CC846	DC1025	10.8 x 8.3 x 2.5	9.2 x 6.6 x 2.5	0.07	0.5	CA568	7	CA571	5	CA556**	CC314	
CC641	CC934	CC946	DG91035	10.9 x 8.3 x 3.5	9.2 x 6.6 x 3.0	0.10	0.9	CC659	7	CC650	5	CD437*	CF351	
CC642	CC935	CC947	DG91050	10.9 x 8.3 x 5.0	9.2 x 6.6 x 4.5	0.19	1.2	CC660	7	CC651	5	CD437*	CF352	
CA565	CC836	CC849	DC2025	16.5 x 10.9 x 2.5	14.8 x 9.2 x 2.5	0.16	0.9	CA571	11	CA577	7	CA561**	CC314	
CC643	CC936	CC948	DG92035	16.5 x 10.9 x 3.5	14.9 x 9.3 x 3.0	0.24	1.42	CC661	11	CC652	7	CD438*	CF351	
CC644	CC937	CC949	DG92060	16.5 x 10.9 x 6.0	14.9 x 9.3 x 5.5	0.44	1.88	CC662	11	CC653	7	CD438*	CF352	
CA566	CC840	CC853	DC2070	16.5 x 10.9 x 7.0	15.0 x 9.3 x 7.0	0.51	1.7	CA575	11	CA581	7	CA561**	CA446/CC314	
CC645	CC938	CC950	DG92080	16.5 x 10.9 x 8.0	14.9 x 9.3 x 7.5	0.60	2.5	CC663	11	CC654	7	CD438*	CF353	
CC646	CC939	CC951	DG93030	22.5 x 17.5 x 3.0	20.6 x 15.6 x 2.5	0.44	2.5	CC664	15	CC655	11	CD439*	CF351	
CA567	CC842	CC855	DC3050	22.4 x 17.4 x 5.0	20.3 x 15.3 x 5.0	0.79	2.6	CA584	15	CA588	11	CD456**	CA446/CC314	
CC647	CC940	CC952	DG93060	22.5 x 17.5 x 6.0	20.6 x 15.6 x 5.5	0.97	4	CC665	15	CC656	11	CD439*	CF352	
CC648	CC941	CC953	DG93080	22.5 x 17.5 x 8.0	20.6 x 15.6 x 7.5	1.32	4.67	CC666	15	CC657	11	CD439*	CF353	
CC649	CC942	CC954	DG93120	22.5 x 17.5 x 12.0	20.6 x 15.6 x 11.5	2.03	5.67	CC667	15	CC658	11	CD439*	CF353	

* Grey, red and blue covers available. ** Grey and blue covers available.

DISTRIBUTION CONTAINERS

These reusable, returnable, attached-lid containers are ideal for use in wholesale product distribution and as picking containers. Hinged covers with tight interlocking fit provide maximum security and protection. Containers stack with lids closed and nest with lids open for optimum use of space in trucks, trailers or on pallets. Pebble grain bottom surface provides extra traction on conveyors. Load capacity per container is a maximum of 70-75 lbs. Bottom container will support 250 to 300 lbs. when stacked. (Please inquire for exact load capacities). Flipak™ containers are available in polyethylene plastic (PE) and polypropylene plastic (PP).

FLIPAK® POLYETHYLENE PLASTIC (PE) DISTRIBUTION CONTAINERS

- High-density polyethylene (HDPE) construction offers maximum product protection from moisture, impact and chemicals



ORBIS

Grey	Model No.		Outside Dimensions			Volume cu. ft.	Nesting Ratio	Wt. lbs.
	Red	Blue	Top L" x W" x H"	Bottom L" x W"				
LESS THAN 2.0 CU.FT.								
CA452	-	CF265	11.8 x 9.8 x 7.7	9.3 x 7.0	0.3	2.8:1	2.1	
CA453	-	CF266	15.2 x 10.9 x 9.7	12.8 x 7.8	0.6	4.0:1	3.0	
CA454	-	-	21.8 x 15.1 x 5.5	18.9 x 13.7	0.7	3.6:1	4.8	
CA455	-	CF268	19.7 x 11.8 x 7.3	16.9 x 9.3	0.7	3.0:1	3.4	
CA456	-	-	20.6 x 13.5 x 6.5	18.2 x 11.7	0.8	2.1:1	5.2	
CA457	-	-	20.6 x 13.2 x 11.6	17.7 x 11.0	1.4	4.4:1	5.9	
CF559	CF556	CF557	21.9 x 15.2 x 9.3	19.1 x 13.3	1.3	4.4:1	5.0	
CA461	-	CF273	22.3 x 13.0 x 12.8	19.1 x 10.9	1.6	3.8:1	6.2	
CA462	CA463	CF274	21.8 x 15.2 x 12.9	18.6 x 12.9	1.8	4.0:1	6.5	
CA464	-	-	23.5 x 15.7 x 13.0	19.9 x 13.0	1.9	4.5:1	6.9	
2.0 CU.FT. & GREATER								
CF504*	CF503*	CF506*	26.9 x 16.9 x 12.1	24.4 x 14.7	2.4	4.2:1	8.2	
CA468	CA469	CF277	23.9 x 19.6 x 12.6	21.1 x 17.1	2.7	5.3:1	8.4	
CA471	-	-	39.0 x 14.0 x 13.0	36.3 x 11.3	3.3	4.9:1	10.4	
CA475	-	-	30.0 x 22.0 x 20.5	27.4 x 19.4	6.1	4.0:1	17.0	

*Dollies available for these sizes

FLIPAK® DOLLY

- Inside Dimensions: 24.4" L x 14.6" W
- Outside Dimensions: 26.9" L x 16.9" W
- Height Without Casters: 7"
- Allows for easy and efficient transport of multiple for Flipak® containers
- High corner supports hold totes in place
- Dollies securely stack together
- Easily cleanable
- All-plastic construction is durable, increases service life and reduces product damage
- Rugged rubber casters withstand varying ground surfaces
- Standard 3" casters included
- Compatible with CF503-CF506

Model No. CF936



ORBIS

FLIPAK® CLEAR POLYPROPYLENE PLASTIC (PP) DISTRIBUTION CONTAINERS

- Offer all the same benefits as the polyethylene containers, plus provide easy content identification
- Polypropylene (PP) is the same family as polyethylene
- Polypropylene's advantages over polyethylene include its greater stiffness and elevated use
- Temperature range: 30°F - 150°F



ORBIS

Model No.	Outside Dimensions			Volume cu. ft.	Nesting Ratio	Wt. lbs.
	Top L" x W" x H"	Bottom L" x W"				
LESS THAN 2.0 CU.FT.						
CC128	11.8 x 9.8 x 7.7	9.3 x 7.0	0.3	2.8:1	2.1	
CC129	15.2 x 10.9 x 9.7	12.8 x 7.8	0.6	4.0:1	3.0	
CC130	19.7 x 11.8 x 7.3	16.9 x 9.3	0.7	3.0:1	3.4	
CF558	21.9 x 15.2 x 9.8	19.1 x 13.3	1.4	4.4:1	5.0	
CC132	21.8 x 15.2 x 12.9	18.6 x 12.9	1.8	4.0:1	6.2	
2.0 CU.FT. & GREATER						
CF505*	26.9 x 16.9 x 12.1	24.4 x 14.7	2.3	5.3:1	7.8	

*Dollies available for these sizes

PLASTIC LATCH CONTAINERS

- Feature heavy-duty latches on each end that snap lock providing a tight and secure fit
- Injection molded from durable, high impact polypropylene
- Volume: 7 gallons
- Capacity: 50 lbs.



SYSTÈME DE RANGEMENT QUANTUM^{MC}

Model No.	Colour	Dimensions			Weight lb
		W" x D" x H"			
CONTAINERS					
CG053	Black	15-7/8 x 21 x 7-3/4			2
CG054	Clear	15-7/8 x 21 x 7-3/4			2
LIDS					
CG055	Black	15-7/8 x 21			
CG056	Clear	15-7/8 x 21			

BINS & SUPPORT RACKS

METAL BIN SUPPORT RACKS

- Louvered bin panels can be wall-mounted, attached to back of shelving, mounted on benches, carts, inside cabinets, fastened to slotted angle components or used for service truck interiors
- Bins are easily removed, refilled and replaced
- Each heavy-duty panel is 16-gauge cold-rolled steel
- Slotted holes 3/4" L x 3/8" W at 6" centres simplify installation
- Kleiton grey powder coated
- Installation note:** Panels must be securely fastened to materials of adequate load bearing strength



CF412

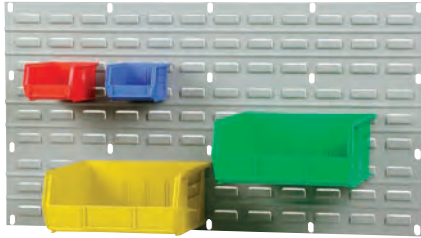

BIN QUANTITY TABLE

Quantity of identical plastic bins that fit CF412 Panel

Bins not included

Panel Height 35 3/4" Wide	Model No.						
	Bin CF820	Bin CF825	Bin CF830	Bin CF835	Bin CF840	Bin CF845	Bin CF850
1 Panel = 19" H	32	32	18	9	8	8	4
2 Panels = 37" H	72	72	36	18	18	16	8
3 Panels = 55" H	104	104	54	27	28	28	14
4 Panels = 73" H	144	144	72	36	36	36	18

For CF411 Panel, use 1/2 of bin quantities shown above

Model No.	Panel Dimensions W" x H"		Wt. lbs.
CF411	18	x 19	6
CF412	36	x 19	12



BENCH LOUVERED RACKS

- All-welded louvered bench rack
- Provides tool and storage for assembly or repair operations when combined with plastic parts bin
- Durable Kleiton blue enamel finish

36" FREE STANDING RACKS

- Free standing unit made of 1" square tube frame
- May be placed on any flat surface near a worksite without the need for bolts or fasteners



CB363



72" BOLT-ON RACKS

- Constructed of 1 1/4" square tube frame
- Designed to be permanently installed on a 72" wide workbench

Model No.	Rack Type	Dimensions			Wt. lbs.
		W"	x D"	x H"	
CB363	Free Standing	36	x 10	x 22	22
CB364	Bolt-On	72	x 15	x 40	95

BINS CARTS

- All-welded bin cart
- Work surface made of 14-gauge steel
- Includes:** 20 bins of various size, bolted-on 5" non-marking casters and two louvered panels
- Capacity: 1000 lbs.
- Durable Kleiton blue enamel finish

BINS SUPPLIED

Bin Qty	Bin Dimensions		
	W"	x D"	x H"
16	8 1/4	x 14 3/4	x 7
4	16 1/2	x 14 3/4	x 7

Model No.	Description	Dimensions			Wt. lbs.
		W"	x D"	x H"	
CB365	Cart Only	24	x 38 1/2	x 36 1/2	95

CART/BIN COMBINATION

Blue	Red	Yellow	Green	Bin Qty	Wt. lbs.
CB366	CB367	CB368	CB689	20	133



CB367



STATIONARY BIN RACKS

- Designed to be permanently installed to the floor
- All-welded stationary bin racks
- Constructed of 1 1/4" square tube frame
- Choose from either single or double-sided racks to meet your storage needs
- Durable Kleiton blue enamel finish
- Includes 28 or 56 bins
- 8 1/4" W x 14 3/4" D x 7" H
- Shipped all-welded



Model No.	Description	Rack Type	Dimensions			Wt. lbs.
			W"	x D"	x H"	
CB373	Rack Only	Single	36	x 12	x 61	60
CB653	Rack Only	Double	36	x 24	x 61	100

RACK/BIN COMBINATION

Blue	Red	Yellow	Green	Rack Type	Bin Qty	Capacity lbs.
CB654	CB655	CB656	CB685	Single	28	1680
CB370	CB371	CB372	CB687	Double	56	3360

ACCESSORIES

Model No.	Description
CC165	Round Hook, 6"
CC166	Round Hook, 12"
CC167	Square Hook, 6"
CC168	Square Hook, 12"

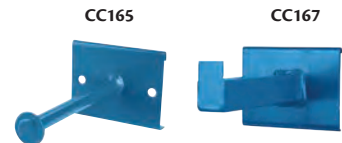

CC165

CC167

MOBILE BIN RACKS

- Ideal for transportation of small parts
- All-welded mobile bin rack
- Single** includes 36 bins 5 1/2" W x 10 7/8" D x 5" H, 3" casters and two louvered panels
- Double cart** includes 96 bins of various sizes, bolted on 5" non-marking casters and six louvered panels
- Capacity: 800 lbs. single sided and 1000 lbs. double sided
- Durable Kleiton blue enamel finish



BINS SUPPLIED

Bin Qty	Bin Dimensions		
	W"	x D"	x H"
36	5 1/2	x 10 7/8	x 5

Model No.	Description	Rack Type	Dimensions			Wt. lbs.
			W"	x D"	x H"	
CB359	Rack only	Single	36	x 16	x 46	60
CB649	Rack only	Double	36	x 24	x 63	120

RACK/BIN COMBINATION

Blue	Red	Yellow	Green	Rack Type	Bin Qty	Wt. lbs.
CB650	CB651	CB652	CB681	Single	36	83
CB089	CB090	CB091	CB683	Double	96	187



CB090
Double-sided

FIBREBOARD BINS & RACKS



CORRUGATED PARTS BINS & DIVIDERS

- Economical standard duty bins constructed of durable corrugated fibreboard
- Ideal for storing any loose small parts
- Assembled easily without staples or tape, just fold
- Bins are designed to hang from the shelf for hands-free access
- Bin dividers not included
- Qty per case: 100
- Shipped knocked down

Standard Corrugated Bins & Dividers



12" DEEP PARTS BINS

Model No.	Ctn. Wt. lbs.	Model No.	Ctn. Wt. lbs.	Dimensions W" x H"
CB063	17	CB056	22	2 x 4 1/2
CB064	19	CB057	27	3 x 4 1/2
CB065	20	CB058	30	4 x 4 1/2
CB066	25	CB059	38	6 x 4 1/2
CB067	31	CB060	45	8 x 4 1/2
CB068	36	N/A	-	9 x 4 1/2
CB052	38	CB054	50	10 x 4 1/2
CB053	44	CB055	57	12 x 4 1/2

18" DEEP PARTS BINS

3 5/8" DEEP REMOVABLE DIVIDERS

Model No.	Dimensions W" x H"	Ctn. Wt. lbs.	Model No.	Dimensions W" x H"	Ctn. Wt. lbs.
CB071	1 3/4 x 4 1/8	7	CB075	7 3/4 x 4 1/8	22
CB072	2 3/4 x 4 1/8	9	CB069	9 3/4 x 4 1/8	27
CB073	3 3/4 x 4 1/8	10	CB070	11 3/4 x 4 1/8	31
CB074	5 3/4 x 4 1/8	14			



Removable dividers ease handling

SINGLE-SIDED PICK-RACKS

- Units are free standing, but may be bolted to bench top, floor or wall
- 61" high floor model comes with 48-4" plastic storage bins and 10-6" plastic storage bins or 48-4" corrugated bins and 8-8" corrugated bins
- 21 1/2" high bench model comes with 16-4" plastic storage bins, and 5-6" plastic storage bins or 16-4" corrugated storage bins and 4-8" corrugated storage bins
- Order complete with plastic shelf bins, fibreboard bins or rack only
- Grey enamel finish
- Shipped knocked down

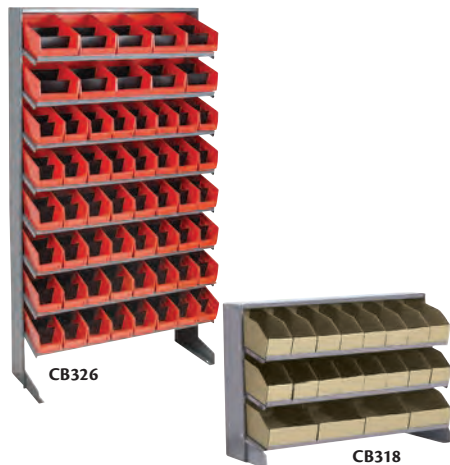

DOUBLE-SIDED MOBILE PICK-RACKS

- 22-gauge steel rack components mounted on a 26" x 36" dolly
- 3" casters
- Each rack accommodates 96-4" wide storage bins and 20-6" wide bins
- Order complete with plastic shelf bins, fibreboard bins or rack only
- Grey enamel finish
- Shipped knocked down

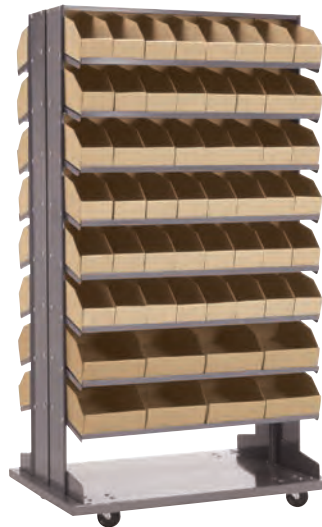

BIN/PEGBOARD COMBO RACK

- Mobile rack designed with (1) side pegboard & (1) side louvered panels (2 continuous)
- All-welded construction
- Square tube frame with angle iron base
- Equipped with (4) 5" non-marking, blue rubber casters (2 swivel, 2 rigid)
- Durable Kleton Blue enamel finish
- Bins not included



Model No.	Dimensions W" x D" x H"	Bin Type	Wt. lbs.		
CB318	32 7/8 x 12 1/8 x 21 1/2	Corrugated	22		
CB377	32 7/8 x 12 1/8 x 21 1/2	Rack Only	17		
CB323	33 1/2 x 12 1/4 x 61	Corrugated	57		
CB378	33 1/2 x 12 1/4 x 61	Rack Only	45		
Blue	Red	Yellow			
CB320	CB321	CB322	21 1/2	Plastic	25
CB325	CB326	CB327	61	Plastic	65

Model No.	Dimensions W" x D" x H"	Bin Type	Wt. lbs.		
CB328	33 1/2 x 12 1/4 x 65	Corrugated	139		
CB337	33 1/2 x 12 1/4 x 65	Rack Only	115		
Blue	Red	Yellow			
CB330	CB331	CB332	65	Plastic	155

Model No.	Dimensions W" x D" x H"	Capacity
RN555	38 x 24-1/2 x 55	1000 lbs.



BINS/STORAGE CABINETS

DEEP DOOR COMBINATION CABINETS

- All-welded heavy-duty 16-gauge, combination bin/shelf cabinet
- 4" deep hinged doors
- Unique padlock hasp helps prevent access with bolt cutters
- Powder coated Kleton grey finish
- Padlock sold separately

A. 84 BIN CABINETS

- Four reinforced 16-gauge main adjustable shelves with 500-lb. capacity per shelf
- Incorporates louvered bin hanging panels welded into the cabinets doors

CABINET ONLY

Model No.	Description	Dimensions			Wt. lbs.
		W"	x D"	x H"	
CB442	Cabinet Only	38	x 24	x 72	324
FB025	Extra Shelf	38	x 21 1/4	x 1	18

CABINET WITH BINS

Blue	Model No.			Description	Wt. lbs.
	Red	Yellow	Green		
CB446	CB477	CB448	CB693	Cabinet and Plastic Bins	341

BINS SUPPLIED

Bin Qty	W"	Bin Dimensions			Capacity lbs.
		x D"	x H"		
84	4 1/8	x 5 3/8	x 3	10	

B. 96 BIN CABINETS

- Two reinforced 16-gauge main adjustable shelves with 500-lb. capacity per shelf
- Incorporates louvered bin hanging panels welded to the cabinet's back and doors

CABINET ONLY

Model No.	Description	Dimensions			Wt. lbs.
		W"	x D"	x H"	
FH820	Cabinet Only	38	x 24	x 72	316
FB025	Extra Shelf	38	x 21 1/4	x 1	18

CABINET WITH BINS

Blue	Model No.			Description	Wt. lbs.
	Red	Yellow	Green		
CF371	CF372	CF373	CF374	Cabinet and Plastic Bins	359

BINS SUPPLIED

Bin Qty	W"	Bin Dimensions			Capacity lbs.
		x D"	x H"		
84	4 1/8	x 5 3/8	x 3	10	
12	5 1/2	x 10 7/8	x 5	30	

C. 98 BIN CABINETS

- Two reinforced 16-gauge main adjustable shelves with 500-lb. capacity per shelf
- Incorporates louvered bin hanging panels welded to the cabinet's back and doors

CABINET ONLY

Model No.	Description	Dimensions			Wt. lbs.
		W"	x D"	x H"	
FH820	Cabinet Only	38	x 24	x 72	316
FB025	Extra Shelf	38	x 21 1/4	x 1	18

CABINET WITH BINS

Blue	Model No.			Description	Wt. lbs.
	Red	Yellow	Green		
CF355	CF356	CF354	CF357	Cabinet and Plastic Bins	385

BINS SUPPLIED

Bin Qty	W"	Bin Dimensions			Capacity lbs.
		x D"	x H"		
48	4 1/8	x 5 3/8	x 3	10	
36	4 1/8	x 7 3/8	x 3	10	
8	8 1/4	x 14 3/4	x 7	60	
6	16 1/2	x 14 3/4	x 7	75	

KLETON



A. CB446
84 Bins



B. CF373
96 Bins



C. CF354
98 Bins



D. CB445
118 Bins

D. 118 BIN CABINETS

- Incorporates louvered bin hanging panels welded to the cabinet's back and doors

CABINET ONLY

Model No.	Description	Dimensions			Wt. lbs.
		W"	x D"	x H"	
CB441	Cabinet Only w/o Shelves	38	x 24	x 72	316

CABINET WITH BINS

Blue	Model No.			Description	Wt. lbs.
	Red	Yellow	Green		
CB443	CB444	CB445	CB691	Cabinet and Plastic Bins	385

BINS SUPPLIED

Bin Qty	W"	Bin Dimensions			Capacity lbs.
		x D"	x H"		
42	4 1/8	x 5 3/8	x 3	10	
42	4 1/8	x 7 3/8	x 3	10	
18	5 1/2	x 10 7/8	x 5	30	
12	8 1/4	x 14 3/4	x 7	60	
4	16 1/2	x 14 3/4	x 7	75	



HEAVY-DUTY PARTS CABINETS

- New design allows 98% use of drawer space to store larger tools or materials
- Housed in an all-welded 22-gauge galvanized steel cabinet
- I.D. card with clear plastic shield and divider included with every drawer
- Steel tabs and drawer stoppers allow for full extension without risk of spilling
- Cabinet has either polystyrene or heavy-duty ABS beige drawers
- Grey enamel finish

CA891



CF283

CA889



CD440



CC453



CA890



CF293

Model No.	No. of Drawers	Drawer Description	Drawer Dimensions			Cabinet Dimensions			Wt. lbs.				
			W"	x	D"	x	H"	W"		x	D"	x	H"
CF311	18	Polystyrene	3.5	x	8.6	x	2.2	13.9	x	8.7	x	16.3	19
CF312	20	Polystyrene	3.5	x	8.6	x	2.2	18.3	x	8.7	x	13.8	21
CF314	40	Polystyrene	3.5	x	8.6	x	2.2	18.3	x	8.7	x	25.3	40
CF313	25	Polystyrene	3.5	x	8.6	x	2.2	23.1	x	8.7	x	13.8	27
CF315	75	Polystyrene	3.5	x	8.6	x	2.2	23.1	x	8.7	x	36.9	66
CF305	16	Polystyrene	3.5	x	8.6	x	2.7	18.3	x	8.7	x	13.8	21
CF304	15	Polystyrene	3.5	x	8.6	x	2.7	13.9	x	8.7	x	16.3	22
CC453	32	Polystyrene	3.5	x	8.6	x	2.7	18.1	x	8.7	x	25.6	31
CC454	60	Polystyrene	3.5	x	8.6	x	2.7	22.6	x	8.7	x	36.9	68
CF298	16	ABS	4.7	x	8.6	x	2.7	23.1	x	8.7	x	13.8	24
CA891	24	ABS	4.7	x	8.6	x	2.7	17.3	x	8.7	x	25.6	33
CA892	48	ABS	4.7	x	8.6	x	2.7	22.6	x	8.7	x	36.9	58
CD440*	48	ABS	4.7	x	8.6	x	2.7	22.6	x	10.8	x	36.9	66.8
CA889	30	ABS	5.9	x	9.8	x	3.3	21.3	x	10.4	x	36.9	58
CA890	60	Polystyrene	5.9	x	9.8	x	1.6	21.3	x	10.4	x	36.9	60
CF293	18	Polystyrene	5.9	x	9.8	x	1.6	21.3	x	10.4	x	12.2	25
CF283	12	ABS	6.4	x	11.3	x	2.7	23	x	11.4	x	13.8	28
CF285	36	ABS	6.4	x	11.3	x	2.7	23	x	11.4	x	36.9	60

* Comes with locking doors

HEAVY-DUTY INDUSTRIAL CAROUSEL DRAWER CABINETS

- Create your customized carousel cabinet
- Each level accommodates four parts cabinets with same height
- For a multiple tier cabinet (maximum three tiers), you require add-on-shelves and threaded rods as per the following:
One add-on-shelf **CF402** for each level of cabinets
14" rod required for each level of **CF312** or **CF305** cabinets
25" rod required for each level of **CC453** or **CF314** cabinets
- Rotational base allows for 800-lb. capacity
- All-welded 11-gauge steel base
- Durable Kleton grey enamel finish

Model No.	Description	Dimensions			Wt. lbs.		
		W"	x	D"		x	H"
3 TIER CABINETS KITS							
CF405	192 Drawers	27	x	27	x	48	392
CF406	240 Drawers	27	x	27	x	48	407
CF407	384 Drawers	27	x	27	x	80	497
CF408	480 Drawers	27	x	27	x	80	600
COMPONENTS							
CF401	Base and Top Cover	27 1/2	x	27 1/2	x	4	80
CF402	Add-on Shelf	27 1/2	x	27 1/2	x	1	18
CF403	Threaded Rod - 14"	3/8	x	-	x	14	1
CF404	Threaded Rod - 25"	3/8	x	-	x	25	1.5
CF305	Parts Cabinet - 16 Drawers	18 5/16	x	8 11/16	x	14	21
CF312	Parts Cabinet - 20 Drawers	18 5/16	x	8 11/16	x	14	21
CC453	Parts Cabinet - 32 Drawers	18 5/16	x	8 11/16	x	25	31
CF314	Parts Cabinet - 40 Drawers	18 5/16	x	8 11/16	x	25	40



CF408 (Kit)



INCLUDES:

- 12 - CF314 - Cabinet - 40 drawers
- 1 - CF401 - Base and Top Cover
- 2 - CF404 - Threaded Rod 25"
- 2 - CF402 - Add-on Shelf

PARTS CABINETS

CAROUSEL DRAWER CABINETS

- Designed to utilize open and often unused areas such as corners
- Optional turntable can be used to create a rotary carousel unit providing convenience for accessing small parts storage
- All-welded cabinets include clear drawers, dividers and I.D. labels
- Cabinet overall dimension: 12" W x 5 3/4" D x 22" H
- Blue enamel finish
- Turntable **CA912** may be set up with up to three levels of four cabinets per level

Model No.	No. of Drawers	Drawer Model No.	Drawer Dimensions				Wt. lbs.
			W"	x	D"	x H"	
CA870	60	CD441	2	x	5 5/16	x 1 3/8	10.7
CA869	48	CD442	2 1/2	x	5 5/16	x 1 3/8	10.7
CA868	30	24 x CD442	2 1/2	x	5 5/16	x 1 3/8	10.7
		4 x CD443	5 5/16	x	5 5/16	x 2 1/4	-
		2 x CD444	11	x	5 5/16	x 2 1/4	-
CA867	16	CD443	5 5/16	x	5 5/16	x 2 1/4	10.3
CA912	-	3 Tier Turntable Unit Only				40.0	



CA867
16-Drawer Cabinet



CA868
30-Drawer Cabinet



CA869
48-Drawer Cabinet



CA870
60-Drawer Cabinet

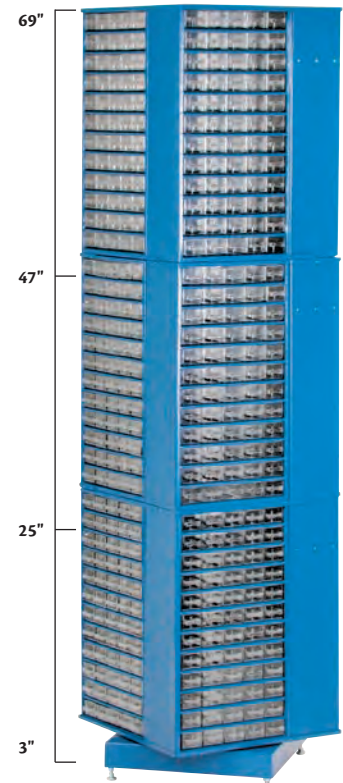

CA912 - Turntable Base
Turntable unit shown with 12 CA870 cabinets (sold separately)

PLASTIC DRAWER CABINETS

- Durable, high-impact polypropylene frame with clear polypropylene drawers and bins
- Heavy-duty reinforced construction
- See-through drawers come with dividers
- Pre-drilled holes on rear side allow easy wall mounting
- Drawer stops prevent bins from falling out
- Colour: Black



CG061



CG066



Model No.	W"		Size D"	x		H"	No. of Drawers	Weight lbs.
	W"	x		D"	x			
CG061	10-1/2	x	6-1/4	x	10-1/4	12	3	
CG062	15	x	6-1/4	x	18-3/4	18	5	
CG063	19-1/2	x	6-1/4	x	10	22	5	
CG064	15	x	6-1/4	x	18-3/4	39	6	
CG065	15	x	6-1/4	x	18-3/4	60	7	
CG066*	15	x	6-1/4	x	18-3/4	30	6	

* Contains 9 large open-front bins

Ask us about volume prices!



In many cases you will benefit from quantity prices.

WORKBENCH SMALL PARTS CABINETS

- Ideal for storing small parts right on your workbench
- New design allows for 98% use of drawer space
- I.D. cards and dividers included with every drawer
- Heavy-duty ABS beige drawers
- 30 drawers, dimensions: 6.5" W x 14.8" D x 4.1" H
- Cabinet: 34.6" W x 15.7" D x 34.6" H
- Housed in an all-welded galvanized steel container finished in a grey enamel paint
- Weight: 119 lbs.

Model No. CF323



KLETON



CF318



CF319

KPC-700 PARTS CABINETS

- Drawer size: 4.7" W x 8.6" D x 2.2" H
- Clear polystyrene drawers

KLETON

Model No.	No. of Drawers	Dimensions			Wt. lbs.
		W"	D"	H"	
CF318	20	23.1	8.7	13.6	25
CF319	30	17.5	8.7	25.3	40
CF320	60	23.1	8.7	36.9	71

HEAVY-DUTY DRAWER CABINETS

- Heavy-duty parts cabinets feature break resistant high impact clear plastic "scoop" drawers for easy removal of small parts, with two adjustable compartment dividers
- Drawers dimensions: 2 7/8" W x 5 1/2" D x 1 7/8" H
- Welded steel cabinets are finished in grey powder coat

DURHAM MFG
Est. 1922

Model No.	No. of Drawers	Cabinet Dimensions			Wt. lbs.
		W"	D"	H"	
CA899	64	25 1/2	6 1/2	21 3/4	34
CA898	20	16 1/2	6 1/2	11 1/4	12



CA899



CA898

MODULAR PARTS CABINETS

- Organize and control small parts inventory
- Standard cabinets come with light grey polystyrene drawers that are virtually indestructible
- Transparent windows on drawer fronts
- Label holder on drawer pull allows for instant identification
- Comes with two removable dividers per drawer
- Stackable steel cabinet frames finished in grey baked enamel
- Cabinet frame dimensions: 17" W x 11" D x 11" H
- **Includes:** Two dividers and one label per drawer

CA853



CA854



CA857



CA858



CA856

Model No.	No. of Drawers	Drawer Dimensions			Wt. lbs.	Dividers Model No.	Replacement Drawers Model No.
		W"	D"	H"			
CA853	28	2 3/16	10 9/16	2 1/16	24	CB126	CA859
CA854	20	3 3/16	10 9/16	2 1/16	21	-	CC143
CA856	16	4	10 9/16	2 1/8	20	CA878	CA860
CA857	15	3 3/16	10 9/16	3 1/16	20	-	CA863
CA858	9	5 3/16	10 9/16	3 1/16	18	-	CA865

AKRO-MILS
CANADA

STEEL DRAWER CABINETS & CARTS

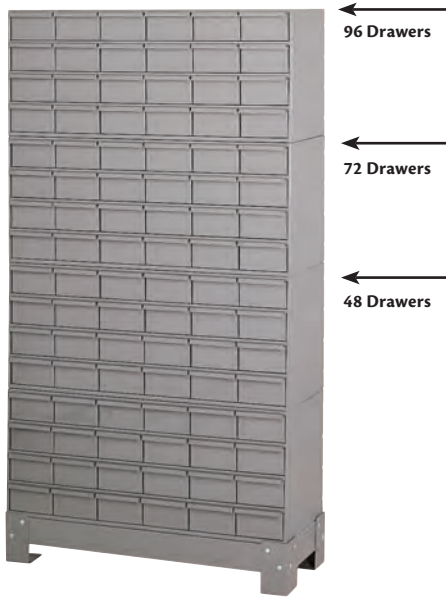

96 Drawers

72 Drawers

48 Drawers



B. 18-Drawer Cabinets



D. 9-Drawer Cabinets



C. 24-Drawer Cabinets



E. 30-Drawer Cabinets

A. 48, 72 & 96-Drawer Cabinets,
Base included

INDUSTRIAL DRAWER CABINETS

- Provide a rugged modular storage system for small parts
- Select from a range of drawer capacities from 9 drawers to 96 drawers per cabinet
- Various drawer sizes are available including drawer heights of 2 3/4" and 3 1/2", and drawer depths of 11 1/8" and 17"
- Each drawer includes two adjustable dividers and full width handles
- Drawer sides are slotted to hold dividers

Type	Model No.	No. of Drawers	Drawer Dimensions				Cabinet Height"	Wt. lbs.	Replacement Drawers
			W"	x	D"	x H"			
A	FI356	30	5 3/8	x	11 1/8	x 3 1/2	26 7/8	107	CD661
A	CA936	48	5 3/8	x	11 1/8	x 2 3/4	33 3/4	176	CA921
A	FI357	60	5 3/8	x	11 1/8	x 3 1/2	48	194	CD661
A	CA939	72	5 3/8	x	11 1/8	x 2 3/4	48 1/8	238	CA921
A	FI358	90	5 3/8	x	11 1/8	x 3 1/2	69 1/8	281	CD661
A	CA941	96	5 3/8	x	11 1/8	x 2 3/4	62 1/2	300	CA921
B	CA924	18	5 3/8	x	11 1/8	x 2 3/4	10 7/8	50	CA921
B	CA925	18	5 3/8	x	11 1/8	x 3 1/2	12 7/8	87	CD661
B	CA926	18	5 3/8	x	17	x 3 1/2	12 7/8	75	CA923
C	CA930	24	5 3/8	x	11 1/8	x 2 3/4	14 3/8	60	CA921
C	CA932	24	5 3/8	x	17	x 3 1/2	17	96	CA923
D	CA942	9	5 3/8	x	11 1/8	x 2 3/4	10 7/8	28	CA921
E	CA934	30	5 3/8	x	11 1/8	x 3 1/2	21 1/8	87	CD661
E	CA935	30	5 3/8	x	17	x 3 1/2	21 1/8	118	CA923
-	CA946	Extra Divider for 2 3/4" H Drawer					-	0.1	-
-	CA947	Extra Divider for 3 1/2" H Drawer					-	0.1	-

DURHAM MFG
Est. 1922

HEAVY-DUTY 2-SIDED MOBILE CART/WORK STATIONS

- Two rigid and two swivel casters with locking brakes
- Sturdy tubular handle allows ease of mobility
- Rubber tray mat provides safe, secure, non-skid work surface
- Finished in rust and acid resistant grey powder coat
- Heavy-duty casters, capacity of 1000 lbs.
- Shipped fully welded

DURHAM MFG
Est. 1922



Front



- Two 12-compartment bins back-to-back
- Overall dimensions: 34" W x 24" D x 32" H
- Ship weight: 139 lbs.

Model No. CD330



- Two 40-compartment bins back-to-back
- Overall dimensions: 34" W x 24" D x 32" H
- Ship weight: 159 lbs.

Model No. CD349

- One lockable 4-compartment storage cabinet
- One storage bin with 12 compartments
- 12 easily dividable pull out storage drawers, six on each side
- Overall dimensions: 34" W x 24" D x 34" H
- Ship weight: 180 lbs.

Model No. MO070



Back

PLASTIC COMPARTMENT CASES

COMPACT POLYPROPYLENE COMPARTMENT BOXES

- High strength, oil resistant polypropylene, boxes with covers fitted with heavy-duty reinforced hinges
- Hinges have a special "stop" feature which allows the cover to remain in open position
- Covers overlap on all sides of the bottom tray
- Two snap latches assure secure closure
- Stackable



DURHAM MFG
Est. 1922



COMPARTMENT BOX CABINETS

- All steel grey powder coated cabinet holds five plastic compartment boxes
- Bolt holes permit stacking and keyhole slots are furnished for wall mounting
- Convenient carrying handle

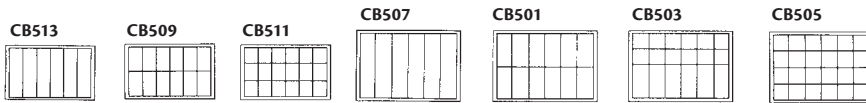

Model No.	Overall Dimensions				No. of Compartments	Compartment Dimensions				Wt. lbs.	
	W"	x	D"	x	H"	W"	x	D"	x	H"	
CB513	11	x	6 3/4	x	1 3/4	1 3/4	x	6 1/4	x	1 9/16	0.7
CB509	11	x	6 3/4	x	1 3/4	1 3/4	x	3 1/8	x	1 9/16	0.7
CB511	11	x	6 3/4	x	1 3/4	1 3/4	x	2 1/16	x	1 9/16	0.7
CB507	13 1/8	x	9	x	2 5/16	2	x	8 1/2	x	2	0.8
CB501	13 1/8	x	9	x	2 5/16	2	x	4 3/32	x	2	0.8
CB503	13 1/8	x	9	x	2 5/16	2	x	(6) 4 3/4 (12) 2	x	2	0.8
CB505	13 1/8	x	9	x	2 5/16	2	x	2	x	2	0.8

COMPARTMENT BOX RACKS (BOXES NOT INCLUDED)

Model No.	Description	W"	x	D"	x	H"	Wt. lbs.
CB631	Small Box Rack	11 1/4	x	6 3/4	x	10 3/4	7
CB632	Large Box Rack	13 1/2	x	9 1/8	x	13 1/4	11

COMPARTMENT CASE

- High strength, high quality polypropylene case
- Translucent lid allows for quick view of contents
- Snap latch ensures a secure closure
- Removable dividers allow for different configurations

TLZ117



CF333

aurora tools

Model No.	Overall Dimensions	No. of Compartments	Wt. lbs.
	W" x D" x H"		
CF333	10 3/4 x 5 3/8 x 1 1/2	Variable up to 17	0.7
TLZ117	5 3/8 x 5 3/8 x 1 3/8	Variable up to 9	0.3

LARGE CASES

18 1/2" L x 13" W

- Large Super Satchel organize tool cribs, maintenance departments, shop floors and allow complete portability
- See-through lids allow quick identification of contents
- Copolymer resins will not rust
- Brass pinned hinges provide strength and durability
- Identification card holder for quick case selection
- Molded integral feet, making ideal presentation cases

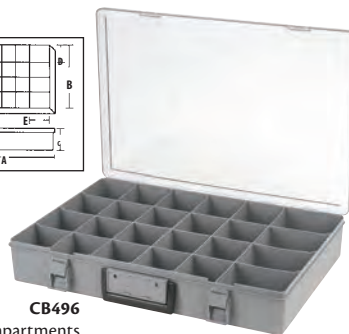
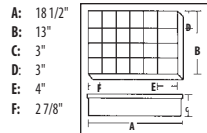

CB496
24 compartments
Wt.: 3.5 lbs.

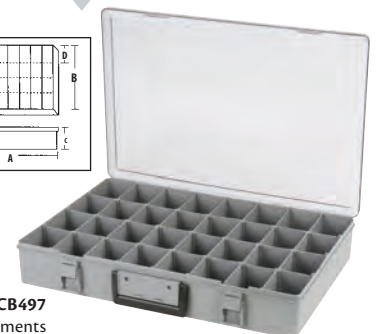
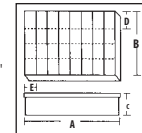

CB497
8 to 32 compartments
24 partitions provided
Wt.: 3.5 lbs.

SMALL CASES

15" L x 11 3/4" W

- Small Satchel store and organize large, medium, small and flat parts, removable partitions
- See-through lids allow quick identification of contents
- Copolymer resins that will not rust or dent
- Brass pinned hinges provide strength and durability
- Divided style (CB499) or double case (CB500) with two cases sonically welded back to back
- Can be stored flat or upright

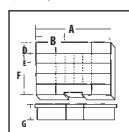
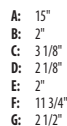

CB499
9 to 24 compartments
Wt. 2.9 lbs.

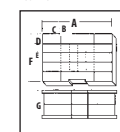
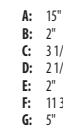

Flambeau



CB500
18 to 48 compartments
Wt. 5.8 lbs.

STORAGE SYSTEMS

TIP-OUT™ BIN MODULAR STORAGE SYSTEMS



- Each bin has a slot for labeling
- Bins can be completely removed for replenishing or cleaning
- Uniform widths of 23.6" (for units of two to nine bins)
- Can be used free-standing or with stands and pedestals

- Transparent compartments tip out for easy access and viewing
- Two of **CB573** disc and screw set are needed for every bin
- Colour: Beige or grey
- Disc and screw set (**CB573**) is required if the bin rack needs to be mounted on a frame

TILT BINS

Model No.		Mfg. No.	No. of Bins	Bin Dimensions					Cabinet Dimensions					Wt. lbs.
Beige	Grey			W"	x	D"	x	H"	W"	x	D"	x	H"	
CB552	CB553	QTB309	9	23 3/16	x	13 3/4	x	2 1/2	23 5/8	x	2 1/2	x	3 1/8	2.0
CB549	CB550	QTB306	6	3 1/2	x	25/8	x	3 3/4	23 5/8	x	3 5/8	x	4 1/2	3.0
CB546	CB547	QTB305	5	4 1/4	x	3 3/4	x	5 3/4	23 5/8	x	5 1/4	x	6 1/2	5.0
CB543	CB544	QTB304	4	5 5/8	x	5	x	7 1/2	23 5/8	x	6 5/8	x	8 1/8	7.0
CB540	CB541	QTB303	3	7 3/8	x	5 7/8	x	8 5/8	23 5/8	x	7 3/4	x	9 1/2	9.0
CB977	CB978	QTB302	2	11 1/16	x	8 7/8	x	13 5/8	23 5/8	x	11 7/8	x	13 7/8	14
CB975	CB976	QTB301	1	11 1/16	x	8 7/8	x	13 5/8	11 3/16	x	11 7/8	x	13 7/8	7

CB573 Two discs and two screws set (1 needed for each bin)

TIP OUT™ FRAMES

- Assembly required
- Disc screw set required for each bin cabinet to be mounted on a frame



FRAME ONLY: BINS NOT INCLUDED

Model No.	Description	Dimensions					Bin Quantity Table QTB Series Bins					
		W"	x	D"	x	H"	302	303	304	305	306	309
FLOOR STANDS												
CB562	48" 1-Sided	23 5/8	x	8	x	52	3	5	6	7	11	16
CB563	70" 1-Sided	23 5/8	x	8	x	75	5	7	8	10	15	23
CB565	48" 2-Sided	23 5/8	x	16	x	52	6	10	12	14	22	32
CB568	70" 2-Sided	23 5/8	x	16	x	75	10	14	16	20	30	46
MOBILE FLOOR STANDS												
CB952	48" 2-Sided	23 5/8	x	16	x	52	6	10	12	14	22	32
CB953	70" 2-Sided	23 5/8	x	16	x	75	10	14	16	20	30	46
WALL FRAMES												
CB559	48"						3	5	6	7	11	16
CB561	70"						5	7	8	10	15	23
CB573	Two Discs & Two Screws Set											

HEAVY-DUTY TILT BINS

- Extremely durable ABS plastic housing and drawer body
- Transparent polystyrene front window for easy viewing
- Conveniently connects to each other with grooved channels on top, bottom and sides
- Shake resistant design prevents drawers from opening on their own
- Keyholes on back for wall mounting applications
- Colour: Black and grey



KLETON

Model No.	No. of Drawers	Bin Dimensions					Cabinet Dimensions					Wt. lbs.
		W"	x	D"	x	H"	W"	x	D"	x	H"	
CF471	8	2 3/4	x	3 1/4	x	3 5/8	11 3/4	x	2 3/4	x	7 7/8	1.8
CF472	6	3 11/16	x	4	x	4 5/8	11 3/4	x	3 1/2	x	9 3/4	2.26
CF473	5	4 1/2	x	4 7/8	x	5 1/2	23 1/2	x	4	x	5 7/8	2.84
CF474	4	5 5/8	x	6 3/8	x	7 1/2	23 1/2	x	5 1/2	x	7 7/8	3.10

ROTABIN STORAGE UNITS

- Revolving units allow for greater accessibility and visibility
- Shelves sit securely on ball bearings held with a solid steel pin
- Each shelf rotates smoothly and independently

17" DIAMETER

- Can be used on counter tops or workbenches
- Each shelf has 4 permanent compartments
- Can have up to 16 compartments per shelf using model CA192 adjustable dividers
- Curved bottom facilitates removal of small parts
- Capacity: 60 lbs. per shelf

28" DIAMETER

- Six permanent 14 1/2" wide compartments per shelf
- Extra CA221 dividers can be inserted on 1" centres
- Capacity: 500 lbs. per shelf

34" DIAMETER

- Five permanent 21" wide compartments per shelf
- Extra CD463 dividers can be inserted on 1" centres
- Optional removable pans for 34" diameter units allow for easy parts inventory, restocking, transporting to work area or to get weighted
- Capacity: 500 lbs. per shelf

DURHAM MFG®
Est. 1922



CA188



CA229 shown with CA258 pans

Model No.	No. of Shelves	No. of Pans*	Unit Height"	Wt. lbs.
UNIT ONLY 17"				
CA188	4	-	18 1/2	25
CA189	6	-	26 1/8	34
CA190	8	-	34 1/2	43
CA191	10	-	42 1/8	52
CA192	Adjustable Divider			
UNIT ONLY 28"				
CA193	5	-	38	125
CA194	6	-	41	144
CA195	7	-	47	163
CA196	8	-	53	182
CA197	9	-	60	201
CA198	10	-	66	220
CA221	Adjustable Divider			
UNIT ONLY 34"				
CA225	4	60	35	135
CA226	5	75	43	162
CA227	6	90	50	188
CA228	7	105	66	215
CA229	8	120	66	240
CD463	Adjustable Divider			
CA258	Grey Pans			

* Max number of pans (pans not included)

MOBILE TILT BIN RACKS

- Heavy-duty steel frame
- Durable powder coat paint finish on galvanized steel
- 3" swivel casters with brake
- Single or double-sided use
- Overall dimensions: 26 1/4" W 22" D x 57 1/2" H
- Colour: Grey



CF475



CF477

KLETON

MOUNTING CHANNELS FOR MOBILE TILT BIN RACK

- Single side of mixed size tilt bins, any combination, takes up to six mounting channels per side
- Single side CF473 tilt bins only takes up to eight mounting channels per side
- CF471 and CF472 takes two bin units per level per side

Model No.	Description	Bin Units Included
CF477	Single-Sided	2 of each CF471, CF472, CF473, CF474
CF478	Double-Sided	4 of each CF471, CF472, CF473, CF474
CF475*	Cart Only	-
CF476	Mounting Channel for Tilt Bins	-
CF502	Mounting Channel for Hanging Bins**	-

* Mounting channels and bins not included

** See page B134 for hanging bins

STEEL COMPARTMENT CASES

COMPARTMENT STEEL SCOOP BOXES

- Manufactured of prime cold-rolled steel
- Fixed compartment boxes
- Choose from between 8 and 32 fixed compartment boxes
- Small box dimensions: 13 3/8" W x 9 1/4" D x 2" H
- Large box dimensions: 18" W x 12" D x 3" H
- Finished in rust and acid resistant baked enamel
- Boxes have inserts of high impact plastic
- Inserts have rounded scoops, making it easy to remove small parts
- All models have covers designed to stay open
- See chart below for box configurations

DURHAM MFG
Est. 1922



FIXED COMPARTMENT CONFIGURATIONS, ORDER BY NUMBER OF COMPARTMENTS

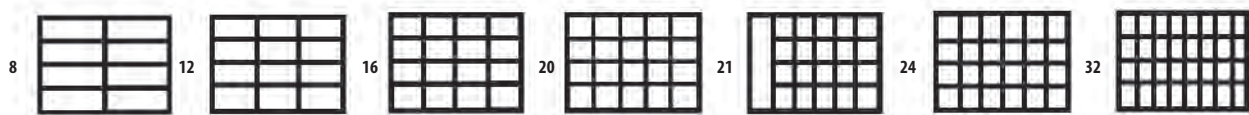

LARGE COMPARTMENT BOXES 18" W x 12" D x 3" H

SMALL COMPARTMENT BOXES 13 3/8" W x 9 1/4" D x 2" H

Number of Compartments	Model No.	Wt. lbs.	Model No.	Wt. lbs.
8	-	-	CB032	4
12	CA986	8	CB015	4
16	CA989	8	CB017	4
20	CA992	8	CB023	4
21	CA995	8	CB026	4
24	CA997	8	CB029	4
32	CB002	8	-	-

COMPARTMENT BOX CABINETS

- Carriages extend 100% of the drawers depth for easy access to parts
- Flexibility of removable drawers and a large selection of drawer configurations
- Drawer cabinet may be mounted on a raised base
- Cabinets are available for both the small and large drawer sizes
- Boxes and base are sold separately
- Optional locking hinge (CB037) prevents boxes from sliding out during transport

DURHAM MFG
Est. 1922

Model No.	Dimensions W" x D" x H"	For Box	Drawer Capacity	Wt. lbs.
CA963	20 x 15 3/4 x 8 1/8	Large	2	20
CA965	20 x 15 3/4 x 15	Large	4	34
CA972	15 1/4 x 11 3/4 x 11 1/4	Small	4	22
CA975	15 1/4 x 11 3/4 x 16 3/8	Small	6	32
CB037	Optional Locking Hinge for CA972	-	-	-
CB038	Optional Locking Hinge for CA965 and CA975	-	-	-

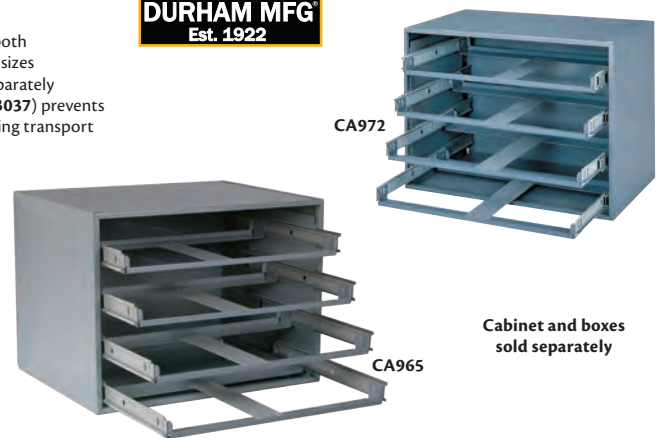

Cabinet and boxes sold separately

ADJUSTABLE COMPARTMENT BOXES

- Adjustable drawers provide the added flexibility of arranging your drawers according to your changing needs
- Removable dividers can be "slotted" into place or removed altogether



DURHAM MFG
Est. 1922

Model No.	Dimensions W" x D" x H"	Description	Wt. lbs.
CA977	18 x 12 x 3	Large	8
CA979	13 3/8 x 9 1/4 x 2	Small	4

CABINET BASES

- Cabinet bases raise your cabinet/drawer combination 12" off of the floor or workbench
- Models are available to adapt to both small and large drawer size cabinets



DURHAM MFG
Est. 1922

Model No.	Overall Dimensions W" x D" x H"	For Box	Wt. lbs.
CA980	20 3/8 x 16 x 15 1/8	Large	13
CA983	15 1/2 x 12 1/8 x 15 1/8	Small	12

MODULAR SMALL PARTS STORAGE UNITS

- Unit is ideal for organization and storage of multipurpose small parts and variety of sized components
- Not included: Mounting/fastening hardware (requires 12 x 1/4" nuts & bolts)
- Steel construction
- Grey powder-coated finish



FN371



FN372



FN373



FN374



FN375



FN376



FN377



FN378

(1) 72-HOLE BOLT BIN, (1) 18-DRAWER CABINET & (1) ELEVATED BASE

- 33-3/4" W x 12-1/4"D x 58-5/8" H
- No. of Drawers: 18
- Weight: 123 lbs.
- Drawer Cabinet Dimensions: 33-3/4" W x 11-5/8" D x 10-7/8" H
- Bolt Bin Dimensions: 33-3/4" W x 12" D x 42" H
- Base Dimensions: 33-3/4" W x 12-1/4" D x 5-3/4" H

Model No. FN371

(1) 40-HOLE BOLT BIN, (1) 18-DRAWER CABINET & (1) ELEVATED BASE

- 33-3/4" W x 12-1/4"D x 40-1/2" H
- No. of Drawers: 18
- Weight: 105 lbs.
- Drawer Cabinet Dimensions: 33-3/4" W x 11-5/8" D x 10-7/8" H
- Bolt Bin Dimensions: 33-3/4" W x 12" D x 23-7/8" H
- Base Dimensions: 33-3/4" W x 12-1/4" D x 5-3/4" H

Model No. FN374

(1) 40-HOLE BOLT BIN, (2) 24-DRAWER CABINETS & (1) ELEVATED BASE

- 33-3/4" W x 12-1/4"D x 58-3/8" H
- No. of Drawers: 48
- Weight: 124 lbs.
- Bolt Bin Dimensions: 33-3/4" W x 12" D x 23-7/8" H
- Drawer Cabinet Dimensions: 33-3/4" W x 11-5/8" D x 14-3/8" H
- Base Dimensions: 33-3/4" W x 12-1/4" D x 5-3/4" H

Model No. FN377

(3) LARGE SLIDE RACKS, (12) LARGE COMPARTMENT BOXES & (1) ELEVATED BASE

- 20-3/8" W x 16" D x 60-1/8" H
- No. of Drawers: 12
- Weight: 48 lbs.
- Large Slide Rack Dimensions: 20" W x 15-3/4" D x 15" H
- Large Compartment Box Dimensions: 18" W x 12" D x 3" H
- Base Dimensions: 20-9/16" W x 16-1/8" D x 15" H

Model No. FN372

(2) LARGE SLIDE RACKS, (8) LARGE COMPARTMENT BOXES, (1) SINGLE-DOOR UTILITY CABINET, (1) 40-HOLE BOLT BIN & (1) ELEVATED BASE

- 33-3/4" W x 12-1/4"D x 59-5/8" H
- No. of Drawers: 8
- Weight: 118 lbs.
- Large Slide Rack Dimensions: 20" W x 15-3/4" D x 15" H
- Large Compartment Box Dimensions: 18" W x 12" D x 3" H
- Utility Cabinet Dimensions: 13-3/4" W x 12-3/4" D x 30" H
- Bolt Bin Dimensions: 33-3/4" W x 12" D x 23-7/8" H
- Base Dimensions: 33-3/4" W x 12-1/4" D x 5-3/4" H

Model No. FN375

(1) SMALL SLIDE RACK, 4 SMALL COMPARTMENT BOXES, (1) 9-DRAWER CABINET, (1) 42-HOLE BOLT BIN & (1) ELEVATED BASE

- 33-3/4" W x 12-1/4"D x 59" H
- No. of Drawers: 13
- Weight: 122 lbs.
- Small Slide Rack Dimensions: 15-1/4" W x 11-3/4" D x 11-1/4" H
- Large Compartment Box Dimensions: 13-1/8" W x 9-1/4" D x 2" H
- Drawer Cabinet Dimensions: 17-1/4" W x 11-5/8" D x 10-7/8" H
- Bolt Bin Dimensions: 33-3/4" W x 12" D x 42" H
- Base Dimensions: 33-3/4" W x 12-1/4" D x 5-3/4" H

Model No. FN378

(1) 42-HOLE BOLT BIN, (1) 18-DRAWER CABINET & (1) ELEVATED BASE

- 33-3/4" W x 12-1/4"D x 58-5/8" H
- No. of Drawers: 18
- Weight: 115 lbs.
- Drawer Cabinet Dimensions: 33-3/4" W x 11-5/8" D x 10-7/8" H
- Bolt Bin Dimensions: 33-3/4" W x 12" D x 42" H
- Base Dimensions: 33-3/4" W x 12-1/4" D x 5-3/4" H

Model No. FN373

(1) DOUBLE-DOOR UTILITY CABINET, (1) 40-HOLE BOLT BIN & (1) ELEVATED BASE

- 33-3/4" W x 12-1/4"D x 55-1/2" H
- No. of Drawers: 0
- Weight: 99 lbs.
- Utility Cabinet Dimensions: 33-3/4" W x 12" D x 23-7/8" H
- Bolt Bin Dimensions: 33-3/4" W x 12" D x 23-7/8" H
- Base Dimensions: 33-3/4" W x 12-1/4" D x 5-3/4" H

Model No. FN376

DURHAM MFG®
Est. 1922

PARTS STORAGE

STEEL STORAGE BINS

- Pigeonhole type steel storage bin units organize small parts
- Best suited where space is limited and organization is crucial
- Produced of prime cold rolled steel
- Fully welded, will not warp, twist or sag
- Fully hemmed label holders provide adequate space for content identification
- Each divider is hemmed in a tear drop design to avoid sharp edges
- Doors with padlock attachment and bases to raise units are available with most models
- All units are 33 3/4" wide and are available in depths of 12" or 8 1/2"
- 12" deep units feature a 45° slope front for easy removal of parts
- Finished in grey powder coat

DURHAM MFG®
Est. 1922

Perfect for organizing your shop - can be filled with just about anything!

CA151



CA152

Doors for storage bins



CA151 with CA141 and CA157



CA154

Base for storage bins



CA157



CA149

CA136



CA133



Model No.	Dimensions					No. of Bins	Bin Dimensions					Wt. lbs.	Base Model No.	Door Model No.
	W"	x	D"	x	H"		W"	x	D"	x	H"			
12" DEEP STORAGE BINS														
CA133	33 3/4	x	12	x	11 1/2	16	4	x	11 7/8	x	5 1/8	25	CA157	-
CA134	33 3/4	x	12	x	19 1/4	18	5 3/8	x	11 7/8	x	6 3/8	38	CA157	-
CA136	33 3/4	x	12	x	23 7/8	24	5 3/8	x	11 7/8	x	5 1/2	44	CA157	-
CA149	33 3/4	x	12	x	23 7/8	40	4	x	11 7/8	x	4 1/2	50	CA157	CA142
CA151	33 3/4	x	12	x	42	42	5 3/8	x	11 7/8	x	5 1/2	71	CA157	CA141
CA152	33 3/4	x	12	x	42	56	4 7/8	x	11 7/8	x	5 1/8	75	CA157	CA141
CA154	33 3/4	x	12	x	42	72	4	x	11 7/8	x	4 1/2	68	CA157	CA141
8 1/2" DEEP STORAGE BINS														
CA150	33 3/4	x	8 1/2	x	22 1/4	40	4	x	8 3/8	x	4 1/2	50	CA158	-
CA155	33 3/4	x	8 1/2	x	42	72	4	x	8 3/8	x	4 1/2	58	CA158	CA141

EZ-EDGE™ SELF ADHESIVE STRIPS

- Self adhesive strip featuring a bottom guide for easy installation and instant organization
- Made of heavy-duty UV treated PVC
- Clear front and black back are barcode compatible
- Can be trimmed to retro-fit many other bins and shelving products
- No inserts included
- Plastic Colour: Clear
- Thickness: 0.15625"
- Height: 1-1/8", Length: 32-5/8"



Model No.	Description
CF798	EZ-Edge™ Self Adhesive Strips - Pack of 5
CF799	EZ-Edge™ Self Adhesive Strips - Pack of 9

REPLACEMENT INSERTS	
OK120	Compatible with all EZ-Edge™ and Tri-Dex™ strips - Inserts per Package: 800
OP955	Compatible with all EZ-Edge™ and Shelf-Clip™ strips - Inserts per Package: 400



BULK STACKING CONTAINERS

- Heavy-duty all-welded construction
- Mesh containers use 2" x 2" x 10 gauge wire mesh
- All containers use a 13-gauge corrugated sheet steel base
- 2" x 2" x 3/16" angle posts
- 4-way fork truck entry with 4" underclearance
- Available with one drop gate or fully enclosed sides
- Height: 24" inside, 30" overall
- Stackable up to five high
- Other sizes are available
- Painted durable Kleton blue



CF457



CF449



CF453

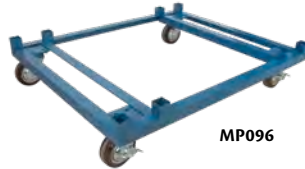

MP096



Model No.	Description	Dimensions W" x L"	Capacity lbs.	Wt. lbs.
MESH CONTAINERS				
CF449	Fully Enclosed	34 1/2 x 40 1/2	3000	125
CF450	One Drop Gate	34 1/2 x 40 1/2	3000	130
CF451	Fully Enclosed	40 1/2 x 48 1/2	3000	150
CF452	One Drop Gate	40 1/2 x 48 1/2	3000	160
SHEET CONTAINERS				
CF453	Fully Enclosed	34 1/2 x 40 1/2	3500	150
CF454	One Drop Gate	34 1/2 x 40 1/2	3500	150
CF455	Fully Enclosed	40 1/2 x 48 1/2	3500	185
CF456	One Drop Gate	40 1/2 x 48 1/2	3500	185
CORRUGATED CONTAINERS				
CF457	Fully Enclosed	34 1/2 x 40 1/2	4500	160
CF458	One Drop Gate	34 1/2 x 40 1/2	4500	160
CF459	Fully Enclosed	40 1/2 x 48 1/2	4500	195
CF460	One Drop Gate	40 1/2 x 48 1/2	4500	195
DOLLY				
MP096	w/ Four Polyurethane Wheels	40 1/2 x 48 1/2	3000	86

COLLAPSIBLE BULK CONTAINER

- Drop gates knock-down with ease
- Quickly collapsed, folded, and stacked for convenient transportation
- Lid sold separately
- Colour: Grey
- Max. Height: 39.4"
- Max. Length: 47.2"
- Max. Width: 39.4"
- No. of Drop Gates: 2
- Material: High-density polyethylene (HDPE)
- Weight Capacity: 2000 lbs.
- Folded Height: 14.2"
- Weight 121.3 lbs. (55 kg.)

Model No. CF862



LID

- For use with Kleton collapsible bulk container
- Material: High-density polyethylene (HDPE)
- Colour: Light Grey
- Weight: 13.2 lbs. (6 kg.)

Model No. CF863



OPEN MESH CONTAINERS

- Rugged construction ensures long-lasting, trouble-free service
- 3/4" - 13 gauge expanded metal mesh panels
- Two half drop gates
- 4-way fork truck access
- 4 1/4" underclearance
- Overall dimensions: 34 1/2" W x 40 1/2" L x 32 1/4" H
- Stackable up to five high
- 15 cu.ft. capacity
- Deck capacity: 2500 lbs. mesh deck, 3000 lbs. sheet metal deck
- Blue enamel finish



Model No.	Style	Wt. lbs.
CA397	Mesh Deck	105
CA398	Sheet Metal Deck	114
CA368	Cup Foot	0.72

STACKING RACKS

- Rugged all-welded 2" square tubing steel construction
- Utilise warehouse airspace and lower the chances of damage that is associated with bulk stacking
- Designed for storage of loose and palletised goods
- Holds 4000 lbs per rack and can be stacked four high
- Posts and bases are sold separately
- Durable Kleton blue enamel finish



Model No.	Inside Dim. W" x D"	Overall Dim. W" x D"	Wt. lbs.
OPEN BASE			
RL414	38 x 44	42 x 48	85
RL415	44 x 48	48 x 48	90
CLOSED BASE			
RL416	38 x 44	42 x 48	110
RL417	44 x 44	48 x 48	115



ACCESSORIES

Model No.	Description	Overall Dim. W" x H"	Wt. lbs.
RL418	42" Side Rail	42 x 48	30
RL419	48" Side Rail	48 x 48	32
RL420	42" Upright Post-Pack of 4	2 x 42	35
RL421	48" Upright Post-Pack of 4	2 x 48	40
RL422	60" Upright Post-Pack of 4	2 x 60	50



COLLAPSIBLE WIRE CONTAINERS

- Welded, square mesh wire allows full visibility and excellent ventilation
- Foldable and constructed of durable 3-gauge wire
- 4-way entry for easy use with lift trucks
- Convenient drop gate design for easy access to products
- Safety rating plates with static load capacity and static load height
- Stack up to four high
- 4" under clearance



Model No.	Dimensions W" x D" x H"	Usable Height"	Drop Gate	Mesh Dim."	Cap. lbs.	Wt. lbs.
CF462	20 x 32 x 21	16	32" Side	1 x 1	1000	43
CF463	20 x 32 x 21	16	32" Side	1/2 x 1/2	1000	55
CF464	32 x 40 x 34 1/2	28	40" Side	2 x 2	4000	122
CF465	40 x 48 x 30 1/2	24	48" Side	2 x 2	4000	150
CF466	40 x 48 x 36 1/2	30	48" Side	2 x 2	4000	163
CF467	40 x 48 x 36 1/2	30	40" End	2 x 2	4000	163
CF468	40 x 48 x 42 1/2	36	48" Side	2 x 2	4000	176